

Catalogo Prodotti

 **adin** | Personal touch
Professional approach



Impegno Qualità Esperienza

Il nostro impegno è stato da sempre quello di realizzare soluzioni che rispondano alle esigenze del clinico e del paziente nel pieno rispetto della sostenibilità. È per questo che da oltre 20 anni i nostri prodotti si distinguono per altissima qualità, costante innovazione, affidabilità e semplicità d'uso.

Benvenuto nel mondo Adin!



A handwritten signature in black ink, reading "Eyal Milman". The signature is written in a cursive style and is positioned above a horizontal line.

Eyal Milman, Adin Group Chairman

Indice



Indice

Connessione a Esagono Interno	Pag.
Touareg™-S	14
Triple™	18
Swell™	22
Vite tappo e Viti di guarigione	26
Kit chirurgico, frese e strumentario	28
Presa d'impronta	33
CAD CAM	38
Protesi Overdenture	54
Chirurgia Guidata	58

Connessione Conica CloseFit™	Pag.
Linea CloseFit™	66
Impianti NP & UNP	68
Vite tappo e Viti di guarigione NP & UNP	71
Kit chirurgico, frese e strumentario	72
Presa d'impronta NP & UNP	77
CAD CAM	82
Protesi Overdenture NP & UNP	100
Chirurgia Guidata	104
Impianti RP & WP	108
Vite tappo e Viti di guarigione RP & WP	112
Frese e strumentario	113
Presa d'impronta RP & WP	117
CAD CAM	122
Protesi Overdenture RP & WP	144
Chirurgia Guidata	148

UniFit™	Pag.
Linea UniFit™	157
Vite tappo e Viti di guarigione	164
Kit chirurgico, frese e strumentario	166
Presa d'impronta	171
CAD CAM	176
Protesi Overdenture	190
Chirurgia Guidata	191

One™	Pag.
Linea One™	198
Analogo	200

Long Implants	Pag.
Touareg™-OS & CloseFit WP	202
Frese e protocollo di foratura	204
Strumentario	205
TMA	206

Zygomatic	Pag.
Touareg™-OS Zygomatic	214
Kit chirurgico	216
Frese e protocollo di foratura	218
Strumentario	220
TMA	221

Kit Stop per Frese	Pag.
KitStop per frese - Regular Long	227
KitStop per frese - Wide Long	228
KitStop per frese - Regular Short	229
KitStop per frese - Wide Short	230

adin | Storia & Obiettivi

2001

Realizzazione del primo stabilimento di produzione

2002

Produzione impianti dentali come terzista

2005

Sviluppo del marchio Adin come brand indipendente

2007

Apertura succursale Adin Russia

2008

Fusione con Med Biomedical, pioniere dell'implantologia dentale dal 1991

2009

Apertura succursale Adin India

Affidabilità

Prodotti certificati secondo i più elevati standard internazionali

Network globale

Presenza e assistenza in oltre 55 Paesi al mondo

Formazione

Ogni anno oltre 500 tra eventi e corsi in tutto il mondo



Vision

Fornire agli odontoiatri i migliori strumenti per riportare il sorriso e migliorare la qualità della vita a milioni di persone, con prodotti accessibili e di qualità superiore.

2012

Vincitore del prestigioso "Outstanding Exporter Award"

2014

Apertura succursale Adin Cina, Colombia & Canada

2016

Apertura succursale Adin USA

2019

1.5% market share del mercato mondiale; 1.3 milioni impianti venduti

2023

Nuovo stabilimento in costruzione, 45.000 m²

2026

Obiettivo: il più grande produttore indipendente a livello globale; 2.5 mln di impianti venduti; 3% market share del mercato mondiale

Mission

Contribuire al progresso della riabilitazione implantare, investendo in sostenibilità, innovazione e soddisfazione del cliente, senza compromessi sulla qualità, sulle garanzie e sugli standard di servizio.



Personal Touch
Professional Approach





Surface Treatment

OsseoFix™ consiste in un trattamento di superficie esclusivo ad elevato coefficiente idrofilico, arricchito con fosfato di calcio ad alta purezza. Concepita per ottenere un livello ottimale di ruvidità, bioattiva con elevate proprietà osteoconduttive, risulta la superficie ideale per implantologia a carico immediato in osso scarsamente vascolarizzato.

Le superfici OsseoFix™ presentano scanalature microscopiche e nanometriche simili al tessuto umano. Trattando la superficie degli impianti con fosfato di calcio, siamo in grado di replicare la componente minerale dell'osso, creando un ambiente familiare per la riproduzione delle cellule ossee.

Le particelle di fosfato di calcio sono parte integrante del miglioramento della biocompatibilità degli impianti ossei.

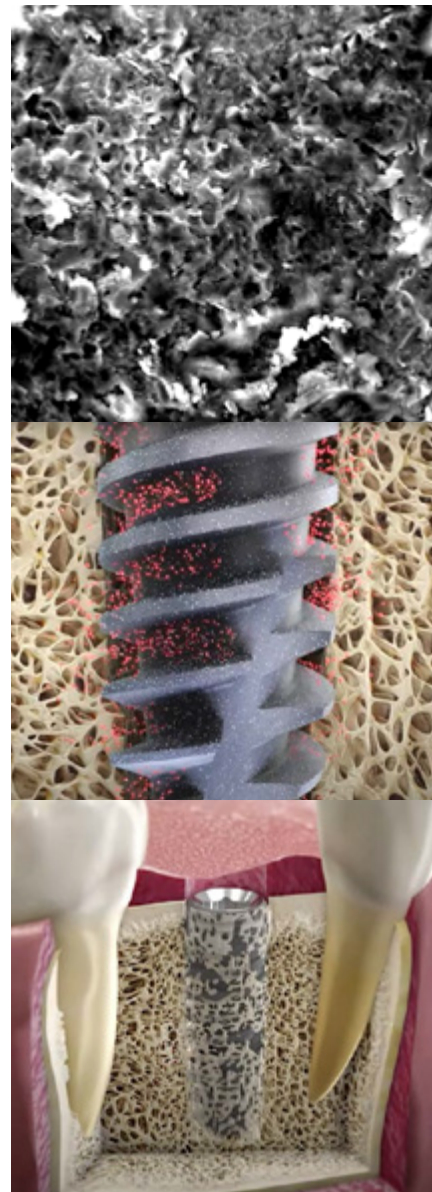

AB/AE (SLA)

presenta una topografia di superficie ruvida micro e nano-strutturata.

Consente un'aderenza ottimale delle cellule e agevola la loro proliferazione nelle cavità della superficie implantare (percentuale di successo clinico del 98.8%).

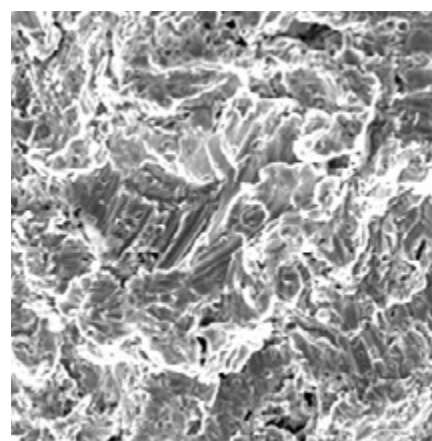

Impianti & Connessioni



Internal Hex



Connessione
esagono interno
Piattaforma
protesica unica

IMPIANTI

Touareg™-S
Triple™
Swell™

Superficie AB/AE (SLA)



CloseFit™

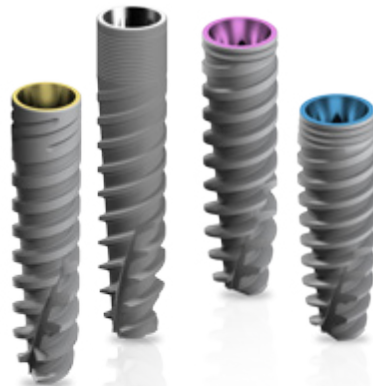

Connessione
conica standard
Piattaforma
protesica multipla

IMPIANTI

Close Fit™ UNP
Close Fit™ NP
Close Fit™ RP
Close Fit™ WP

Superficie OsseoFix™



UniFit™

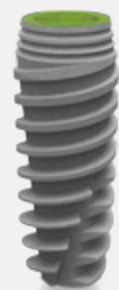

Connessione
conica 7 gradi
Piattaforma
protesica unica

IMPIANTO

UniFit™

Superficie OsseoFix™

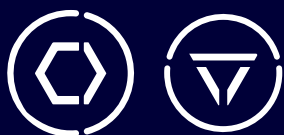

Long Implants



Connessione
esagono interno
Connessione
conica standard

IMPIANTI

Touareg™-OS
Close Fit™ WP

Superficie OsseoFix™



Zygomatic



Connessione
esagono interno

IMPIANTO

Touareg™-OS

Superficie OsseoFix™



One™



Sistema
implantare
monofasico

IMPIANTO

One™

Superficie AB/AE (SLA)



Connessione a Esagono Interno



Touareg™-S

Triple™

Swell™



Touareg™ -S

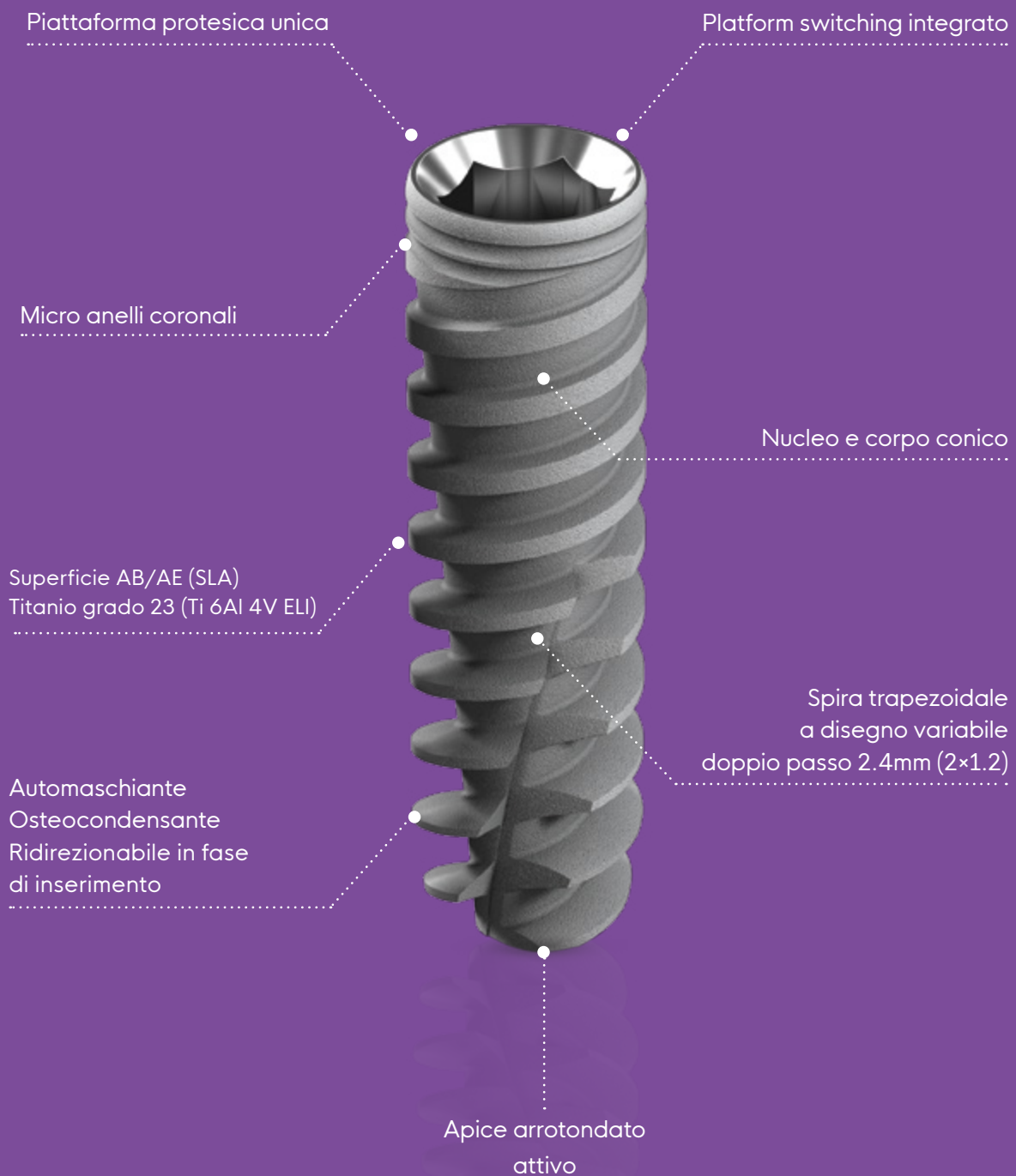

Touareg™-S ha spire attive e dinamiche che consentono di effettuare il carico immediato in tutti i tipi di osso. Identificato come la "pietra miliare" dell'intera gamma, dispone di apice attivo che permette di modificare l'asse di inserimento in caso di piccole correzioni direzionali senza dover procedere con una nuova osteotomia.

Touareg-S™

	Ø mm	L	D3 mm	Codice Art.
	3.5	8.00	3.05	ISPS0835
		10.00	3.00	ISPS1035
		11.50	2.90	ISPS1135
		13.00	2.90	ISPS1335
		16.00	2.90	ISPS1635
		18.00	2.90	ISPS1835
	3.75	8.00	3.15	ISPS0838
		10.00	3.10	ISPS1038
		11.50	3.10	ISPS1138
		13.00	3.05	ISPS1338
		16.00	3.00	ISPS1638
		18.00	3.00	ISPS1838
	4.2	6.25	3.70	ISPS0642
		8.00	3.40	ISPS0842
		10.00	3.40	ISPS1042
		11.50	3.35	ISPS1142
		13.00	3.30	ISPS1342
		16.00	3.25	ISPS1642
	5.0	6.25	4.50	ISPS0650
		8.00	4.20	ISPS0850
		10.00	4.15	ISPS1050
		11.50	4.10	ISPS1150
		13.00	4.10	ISPS1350
		16.00	4.05	ISPS1650
	6.0	6.25	5.50	ISPS0660
		8.00	5.20	ISPS0860
		10.00	5.15	ISPS1060
		11.50	5.10	ISPS1160
		13.00	5.10	ISPS1360

Protocollo di Foratura Touareg^M - OSSO SPONGIOSO

Diametro Impianto	OssO Spongioso	NOTE
3.50	2.0	PREPARARE A TUTTA LUNGHEZZA
	2.8	PREPARARE A TUTTA LUNGHEZZA
	3.2 (2/3)	PREPARARE 2/3 LUNGHEZZA
3.75	2.0	PREPARARE A TUTTA LUNGHEZZA
	2.8	PREPARARE A TUTTA LUNGHEZZA
	3.2 (2/3)	PREPARARE 2/3 LUNGHEZZA
	3.6 (2/3)	PREPARARE 2/3 LUNGHEZZA
4.20	2.0	PREPARARE A TUTTA LUNGHEZZA
	2.8	PREPARARE A TUTTA LUNGHEZZA
	3.2	PREPARARE A TUTTA LUNGHEZZA
	3.6 (2/3)	PREPARARE 2/3 LUNGHEZZA
5.00	2.0	PREPARARE A TUTTA LUNGHEZZA
	2.8	PREPARARE A TUTTA LUNGHEZZA
	3.2	PREPARARE A TUTTA LUNGHEZZA
	3.6	PREPARARE A TUTTA LUNGHEZZA
	4.2	PREPARARE A TUTTA LUNGHEZZA
	4.6 (2/3)	PREPARARE 2/3 LUNGHEZZA
	6.00	PREPARARE A TUTTA LUNGHEZZA
6.00	2.0	PREPARARE A TUTTA LUNGHEZZA
	2.8	PREPARARE A TUTTA LUNGHEZZA
	3.2	PREPARARE A TUTTA LUNGHEZZA
	3.6	PREPARARE A TUTTA LUNGHEZZA
	4.2	PREPARARE A TUTTA LUNGHEZZA
	4.6	PREPARARE A TUTTA LUNGHEZZA
	5.2	PREPARARE A TUTTA LUNGHEZZA
	5.6 (2/3)	PREPARARE 2/3 LUNGHEZZA

Lunghezza fresa 8-18 mm

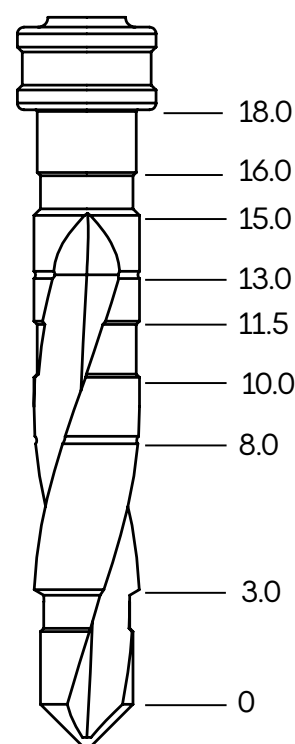

ATTENZIONE

Tutte le misure sono rappresentate in mm.

Nella preparazione del sito implantare considerare che la fresa è 1 mm più lunga della misura dell'impianto.

Protocollo di Foratura Touareg™ - OSSO COMPATTO

Diametro Impianto	OssO Compatto	NOTE
3.50	2.0	PREPARARE A TUTTA LUNGHEZZA
	2.8	PREPARARE A TUTTA LUNGHEZZA
	3.2	PREPARARE A TUTTA LUNGHEZZA
	3.6	PREPARAZIONE CORONALE
3.75	2.0	PREPARARE A TUTTA LUNGHEZZA
	2.8	PREPARARE A TUTTA LUNGHEZZA
	3.2	PREPARARE A TUTTA LUNGHEZZA
	3.6	PREPARARE A TUTTA LUNGHEZZA
4.20	2.0	PREPARARE A TUTTA LUNGHEZZA
	2.8	PREPARARE A TUTTA LUNGHEZZA
	3.2	PREPARARE A TUTTA LUNGHEZZA
	3.6	PREPARARE A TUTTA LUNGHEZZA
	4.2	PREPARAZIONE CORONALE
5.00	2.0	PREPARARE A TUTTA LUNGHEZZA
	2.8	PREPARARE A TUTTA LUNGHEZZA
	3.2	PREPARARE A TUTTA LUNGHEZZA
	3.6	PREPARARE A TUTTA LUNGHEZZA
	4.2	PREPARARE A TUTTA LUNGHEZZA
	4.6	PREPARARE A TUTTA LUNGHEZZA
6.00	2.0	PREPARARE A TUTTA LUNGHEZZA
	2.8	PREPARARE A TUTTA LUNGHEZZA
	3.2	PREPARARE A TUTTA LUNGHEZZA
	3.6	PREPARARE A TUTTA LUNGHEZZA
	4.2	PREPARARE A TUTTA LUNGHEZZA
	4.6	PREPARARE A TUTTA LUNGHEZZA
	5.2	PREPARARE A TUTTA LUNGHEZZA
	5.6	PREPARARE A TUTTA LUNGHEZZA

Lunghezza fresa 8-18 mm

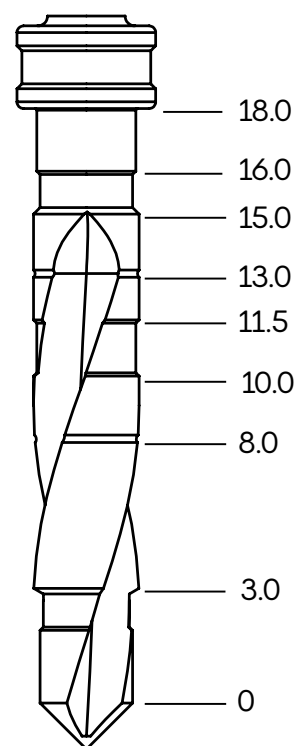

ATTENZIONE

Tutte le misure sono rappresentate in mm.

Nella preparazione del sito implantare considerare che la fresa è 1 mm più lunga della misura dell'impianto.

Triple™

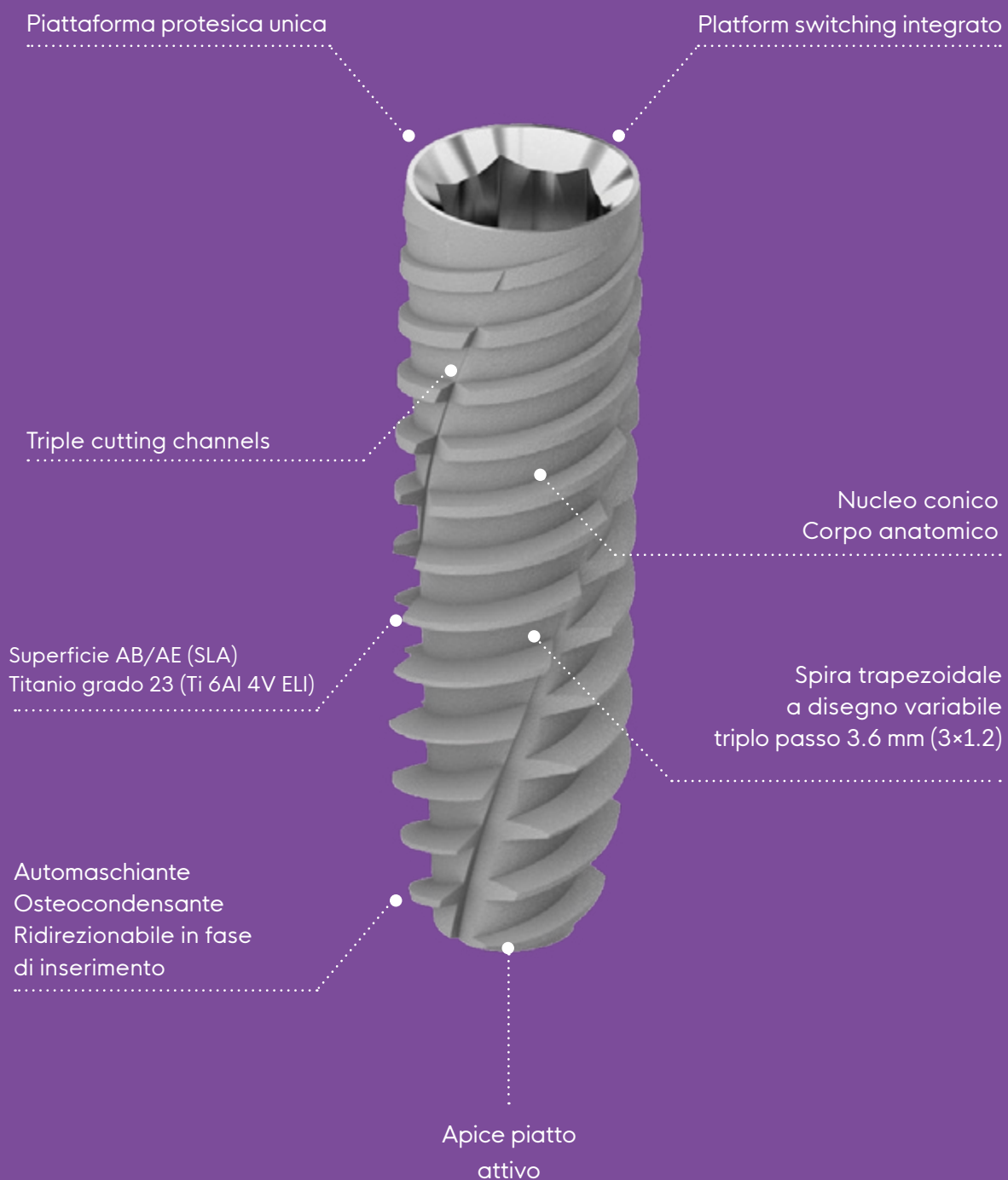

Triple™ dispone di tre canali verticali che consentono un bilanciamento ottimale e la corretta distribuzione delle forze di carico lungo l'asse dell'impianto. Un'unica spira a disegno variabile e triplo passo (3X1.2 mm) ne permette un inserimento fluido e veloce. Ideale per il carico immediato anche in osso a scarsa densità e siti post-estrattivi.

Triple™

	∅	L	D3	Codice Art.
	3.5	8.0	2.65	IST0835
		10.0	2.65	IST1035
		11.5	2.65	IST1135
		13.0	2.65	IST1335
		16.0	2.65	IST1635
	3.75	8.0	2.8	IST0838
		10.0	2.8	IST1038
		11.5	2.8	IST1138
		13.0	2.8	IST1338
		16.0	2.8	IST1638
	4.2	6.25	3.3	IST0642
		8.0	3.3	IST0842
		10.0	3.3	IST1042
		11.5	3.3	IST1142
		13.0	3.3	IST1342
		16.0	3.3	IST1642
	5.0	6.25	4.0	IST0650
		8.0	4.0	IST0850
		10.0	4.0	IST1050
		11.5	4.0	IST1150
		13.0	4.0	IST1350
		16.0	4.0	IST1650
	6.0	6.25	5.0	IST0660
		8.0	5.0	IST0860
		10.0	5.0	IST1060
		11.5	5.0	IST1160
		13.0	5.0	IST1360

Radiographic Template | Triple™ | ASD0616

Protocollo di Foratura Triple™ - OSSO SPONGIOSO

Diametro Impianto	Osso Spongioso	NOTE
3.50	2.0	PREPARARE A TUTTA LUNGHEZZA
	2.8	PREPARARE A TUTTA LUNGHEZZA
	3.2 (2/3)	PREPARARE 2/3 LUNGHEZZA
3.75	2.0	PREPARARE A TUTTA LUNGHEZZA
	2.8	PREPARARE A TUTTA LUNGHEZZA
	3.2 (2/3)	PREPARARE 2/3 LUNGHEZZA
	3.6 (2/3)	PREPARARE 2/3 LUNGHEZZA
4.20	2.0	PREPARARE A TUTTA LUNGHEZZA
	2.8	PREPARARE A TUTTA LUNGHEZZA
	3.2	PREPARARE A TUTTA LUNGHEZZA
	3.6 (2/3)	PREPARARE 2/3 LUNGHEZZA
5.00	2.0	PREPARARE A TUTTA LUNGHEZZA
	2.8	PREPARARE A TUTTA LUNGHEZZA
	3.2	PREPARARE A TUTTA LUNGHEZZA
	3.6	PREPARARE A TUTTA LUNGHEZZA
	4.2	PREPARARE A TUTTA LUNGHEZZA
	4.6 (2/3)	PREPARARE 2/3 LUNGHEZZA
6.00	2.0	PREPARARE A TUTTA LUNGHEZZA
	2.8	PREPARARE A TUTTA LUNGHEZZA
	3.2	PREPARARE A TUTTA LUNGHEZZA
	3.6	PREPARARE A TUTTA LUNGHEZZA
	4.2	PREPARARE A TUTTA LUNGHEZZA
	4.6	PREPARARE A TUTTA LUNGHEZZA
	5.2	PREPARARE A TUTTA LUNGHEZZA
	5.6 (2/3)	PREPARARE 2/3 LUNGHEZZA

Lunghezza fresa 8-18 mm

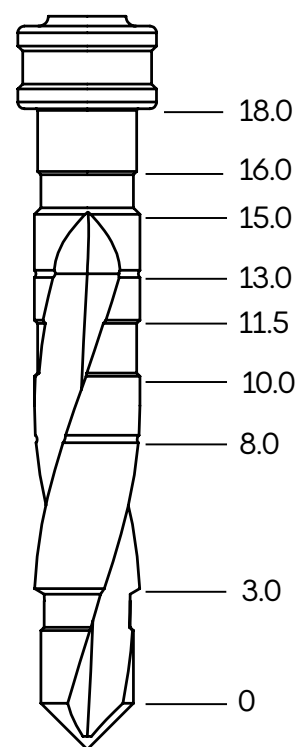

ATTENZIONE

Tutte le misure sono rappresentate in mm.

Nella preparazione del sito implantare considerare che la fresa è 1 mm più lunga della misura dell'impianto.

Protocollo di Foratura Triple™ - OSSO COMPATTO

Diametro Impianto	Osso Compatto	NOTE
3.50	2.0	PREPARARE A TUTTA LUNGHEZZA
	2.8	PREPARARE A TUTTA LUNGHEZZA
	3.2 (2/3)	PREPARARE 2/3 LUNGHEZZA
3.75	2.0	PREPARARE A TUTTA LUNGHEZZA
	2.8	PREPARARE A TUTTA LUNGHEZZA
	3.2	PREPARARE A TUTTA LUNGHEZZA
	3.6 (2/3)	PREPARARE 2/3 LUNGHEZZA
4.20	2.0	PREPARARE A TUTTA LUNGHEZZA
	2.8	PREPARARE A TUTTA LUNGHEZZA
	3.2	PREPARARE A TUTTA LUNGHEZZA
	3.6	PREPARARE A TUTTA LUNGHEZZA
	4.2	PREPARAZIONE CORONALE
5.00	2.0	PREPARARE A TUTTA LUNGHEZZA
	2.8	PREPARARE A TUTTA LUNGHEZZA
	3.2	PREPARARE A TUTTA LUNGHEZZA
	3.6	PREPARARE A TUTTA LUNGHEZZA
	4.2	PREPARARE A TUTTA LUNGHEZZA
	4.6 (2/3)	PREPARARE 2/3 LUNGHEZZA
6.00	2.0	PREPARARE A TUTTA LUNGHEZZA
	2.8	PREPARARE A TUTTA LUNGHEZZA
	3.2	PREPARARE A TUTTA LUNGHEZZA
	3.6	PREPARARE A TUTTA LUNGHEZZA
	4.2	PREPARARE A TUTTA LUNGHEZZA
	4.6	PREPARARE A TUTTA LUNGHEZZA
	5.2	PREPARARE A TUTTA LUNGHEZZA
	5.6 (2/3)	PREPARARE 2/3 LUNGHEZZA

Lunghezza fresa 8-18 mm

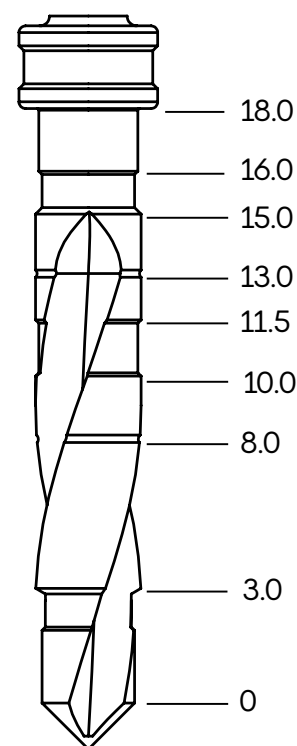

ATTENZIONE

Tutte le misure sono rappresentate in mm.

Nella preparazione del sito implantare considerare che la fresa è 1 mm più lunga della misura dell'impianto.



Piattaforma protesica unica

Platform switching integrato

Micro anelli coronali

Corpo cilindrico
porzione apicale conica

Superficie AB/AE (SLA)
Titanio grado 23 (Ti 6Al 4V ELI)

Spira trapezoidale
a doppio passo
1.2 mm (2X0.6mm)

Automaschiante
Osteocondensante
Ridirezionabile in fase
di inserimento

Apice piatto
attivo

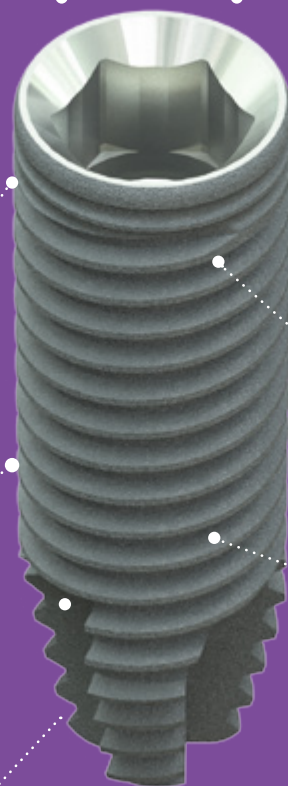

Swell™ è un impianto ibrido con pareti parallele e porzione apicale conica. Il design particolare consente un posizionamento preciso con ottimi risultati estetici e una migliore distribuzione delle forze. Raccomandato in mandibola e in osso con elevata densità.

	Ø mm	L mm	D3 mm	Codice Art.
	3.75	8.00	2.40	ID0838
		10.00	2.30	ID1038
		11.50	2.30	ID1138
		13.00	2.25	ID1338
		16.00	2.20	ID1638
		18.00	2.10	ID1838
	4.2	6.25	2.90	ID0642
		8.00	2.90	ID0842
		10.00	2.80	ID1042
		11.50	2.80	ID1142
		13.00	2.75	ID1342
		16.00	2.70	ID1642
		18.00	2.60	ID1842
	5.0	6.20	3.70	ID0650
		8.00	3.60	ID0850
		10.00	3.60	ID1050
		11.50	3.50	ID1150
		13.00	3.50	ID1350
		16.00	3.40	ID1650
	6.0	6.20	4.70	ID0660
		8.00	4.60	ID0860
		10.00	4.60	ID1060
		11.50	4.50	ID1160
		13.00	4.50	ID1360

Radiographic Template Swell™ | ASD0613

Protocollo di Foratura Swell™ - OSSO SPONGIOSO

Diametro Impianto	Osso Spongioso	NOTE
3.75	2.0	PREPARARE A TUTTA LUNGHEZZA
	2.8	PREPARARE A TUTTA LUNGHEZZA
	3.2 (2/3)	PREPARARE 2/3 LUNGHEZZA
	3.6 (1/2)	PREPARARE 1/2 LUNGHEZZA
4.20	2.0	PREPARARE A TUTTA LUNGHEZZA
	2.8	PREPARARE A TUTTA LUNGHEZZA
	3.2	PREPARARE A TUTTA LUNGHEZZA
	3.6 (2/3)	PREPARARE 2/3 LUNGHEZZA
5.00	2.0	PREPARARE A TUTTA LUNGHEZZA
	2.8	PREPARARE A TUTTA LUNGHEZZA
	3.2	PREPARARE A TUTTA LUNGHEZZA
	3.6	PREPARARE A TUTTA LUNGHEZZA
	4.2 (2/3)	REPARARE 2/3 LUNGHEZZA
	4.6 (2/3)	PREPARARE 2/3 LUNGHEZZA
6.00	2.0	PREPARARE A TUTTA LUNGHEZZA
	2.8	PREPARARE A TUTTA LUNGHEZZA
	3.2	PREPARARE A TUTTA LUNGHEZZA
	3.6	PREPARARE A TUTTA LUNGHEZZA
	4.2	PREPARARE A TUTTA LUNGHEZZA
	4.6	PREPARARE A TUTTA LUNGHEZZA
	5.2 (2/3)	PREPARARE 2/3 LUNGHEZZA
	5.6 (2/3)	PREPARARE 2/3 LUNGHEZZA

Lunghezza fresa 8-18 mm

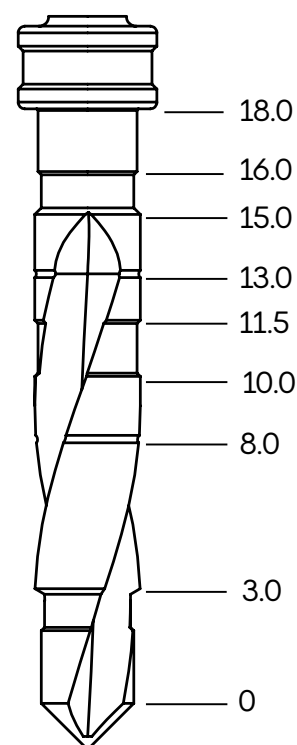

ATTENZIONE

Tutte le misure sono rappresentate in mm.

Nella preparazione del sito implantare considerare che la fresa è 1 mm più lunga della misura dell'impianto.

Protocollo di Foratura Swell™ - OSSO COMPATTO

Diametro Impianto	OssO Compatto	NOTE
3.75	2.0	PREPARARE A TUTTA LUNGHEZZA
	2.8	PREPARARE A TUTTA LUNGHEZZA
	3.2 (2/3)	PREPARARE 2/3 LUNGHEZZA
	3.6 (2/3)	PREPARARE 2/3 LUNGHEZZA
4.20	2.0	PREPARARE A TUTTA LUNGHEZZA
	2.8	PREPARARE A TUTTA LUNGHEZZA
	3.2	PREPARARE A TUTTA LUNGHEZZA
	3.6 (2/3)	PREPARARE 2/3 LUNGHEZZA
	4.2 (1/2)	PREPARARE 1/2 LUNGHEZZA
5.00	2.0	PREPARARE A TUTTA LUNGHEZZA
	2.8	PREPARARE A TUTTA LUNGHEZZA
	3.2	PREPARARE A TUTTA LUNGHEZZA
	3.6	PREPARARE A TUTTA LUNGHEZZA
	4.2	PREPARARE A TUTTA LUNGHEZZA
	4.6 (2/3)	PREPARARE 2/3 LUNGHEZZA
6.00	2.0	PREPARARE A TUTTA LUNGHEZZA
	2.8	PREPARARE A TUTTA LUNGHEZZA
	3.2	PREPARARE A TUTTA LUNGHEZZA
	3.6	PREPARARE A TUTTA LUNGHEZZA
	4.2	PREPARARE A TUTTA LUNGHEZZA
	4.6	PREPARARE A TUTTA LUNGHEZZA
	5.2 (2/3)	PREPARARE 2/3 LUNGHEZZA
	5.6 (2/3)	PREPARARE 2/3 LUNGHEZZA

Lunghezza fresa 8-18 mm

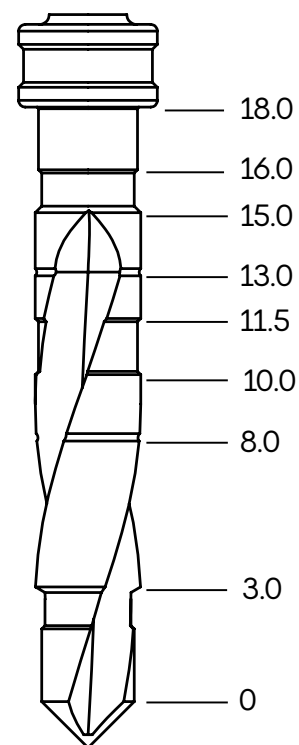

ATTENZIONE

Tutte le misure sono rappresentate in mm.

Nella preparazione del sito implantare considerare che la fresa è 1 mm più lunga della misura dell'impianto.

Vite tappo e Viti di guarigione

Torque raccomandato 15 (Ncm)

RS Vite Tappo Impianto



RS3435

Inclusa nella confezione

RS Vite di Guarigione Slim Regular

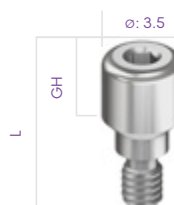

RS3027, GH2/L6.7

RS3028, GH3/L7.7

RS3029, GH4/L8.7

RS3030, GH5/L9.7

RS3031, GH6/L10.7

RS3040, GH7/L11.7

RS Vite di Guarigione Regular

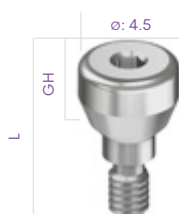

RS3022, GH2/L6.9

RS3023, GH3/L7.9

RS3024, GH4/L8.9

RS3025, GH5/L9.9

RS3026, GH6/L10.9

RS3042, GH7/L11.9

RS Vite di Guarigione Wide



RS3012, GH2/L6.8

RS3013, GH3/L7.8

RS3014, GH4/L8.8

RS3015, GH5/L9.8

RS3016, GH6/L10.8

RS3017, GH7/L11.8

Kit Chirurgico

Connessione Esagono Interno



immagine a solo scopo illustrativo

COMPOSIZIONE RS-NP

- Frese opzionali
- Strumentario chirurgico supplementare
- Strumentario protesico supplementare





Kit Chirurgico Connessione Esagono Interno Composizione Kit RS-NP











cod. ADINKITRS-NP









immagine a solo scopo illustrativo

Composizione RS-NP

FRESE TWIST STEP 8-18mmL							
Fresa Pilota 2mmD	2.3/ 2.8mmD	2.8/ 3.2mmD	3.2/ 3.6mmD	3.8/ 4.2mmD	4.2/ 4.6mmD	4.8/ 5.2mmD	5.2/ 5.6mmD
							
DL1820	DL1828	DL1832	DL1836	DL1842	DL1846	DL1852	DL1856
1	1	1	1	1	1	1	1

DRIVER IMPLANTARI			DRIVER PROTESICI						
RS Adattatore Esagonale Contrangolo -Medium	RS Adattatore Esagonale Contrangolo -Long	NP 2mm Adattatore Esagonale Contrangolo -Medium	1.27 Driver Esagonale Manuale -Short	1.27 Driver Esagonale Manuale -Medium	1.27 Driver Esagonale Cricchetto -Short	1.27 Driver Esagonale Cricchetto -Long	TMA Driver Esagonale Cricchetto -Long	Driver per Cricchetto Star - Long	Driver per Attacco a pallina
									
RS9026	RS9029	NP0074	RS6095	RS6094	RS6080	RS6082	RS6196	RP0005	RS6090
1	1	1	1	1	1	1	1	1	1

FRESE E ACCESSORI CHIRURGICI						
Fresa di Marcatura	Prolunga per Fresa	Sonda di profondità	Pin di Parallelismo 16	Pin di Parallelismo 11	Cricchetto Dinamometrico 15-35Ncm	Adattatore Driver per Cricchetto
						
RS8032	RS9027	RS6180	RS6155	RS6150	RS6112	RA0050
1	1	1	2	1	1	1

Frese opzionali

Frese Chirurgiche Tri-Step

L	Ø		Misura	Codice Art.
	1.8-3.2		short	TD1511
	1.8-3.2		long	TD2218

Frese Chirurgiche Twist Step

L	Ø		Colore	Codice Art.
<p>short</p> <p>6-13mm</p>	2.0		white	DL1320
	1.8-2.5		purple	DL1325
	2.3-2.8		red	DL1328
	2.8-3.2		blue	DL1332
	3.2-3.6		green	DL1336
	3.8-4.2		black	DL1342
	4.2-4.6		yellow	DL1346
	4.8-5.2		brown	DL1352
	5.2-5.6		grey	DL1356
<p>long</p> <p>8-18mm</p>	1.8-2.5		purple	DL1825

Strumentario Chirurgico supplementare

		Codice Art.
	Cricchetto Chirurgico Dinamometrico 35-100 Ncm	RS6111
	Cricchetto	RS6100
	Cacciavite Chirurgico	RS7001

	RS6011		RS6012		RS6097
RS 2.4 Driver Esagonale per Cricchetto-Short	RS6011	RS 2.4 Driver Esagonale per Cricchetto-Long 27mm	RS6012	1.27 Driver Esagonale Manuale 46.4mm	RS6097

	RS9030		RS9035		RS9021
1.27 Driver Esagonale per contrangolo 25mm	RS9030	1.27 Driver Esagonale per contrangolo 30mm	RS9035	RS Adattatore Esagonale per Contrangolo - 23.7 mm	RS9021

Strumentario Protesico supplementare

Star (Per TMA angolato/Vite protesica TMA)



Driver per Cricchetto Star-Short RP0065



Driver Manuale Star-Long RP0004



Driver Manuale Star-Short RP0064

Driver TMA dritti



TMA Driver Esagonale per Cricchetto - Short RS6197



TMA Driver Esagonale Manuale -Long RS6191



TMA Driver Esagonale Manuale-Short RS6193



TMA Adattatore Esagonale per Contrangolo-Long RS6195A



TMA Adattatore Esagonale per Contrangolo-Short RS6194

Presca d'impronta

Torque raccomandato 15 (Ncm)

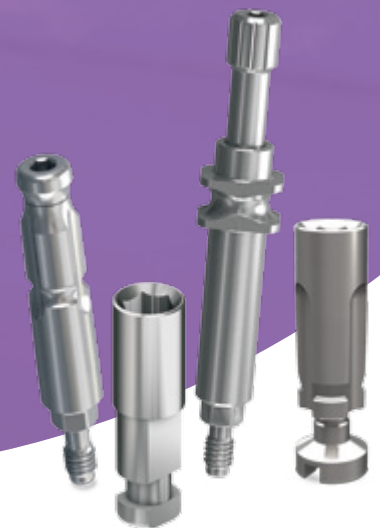

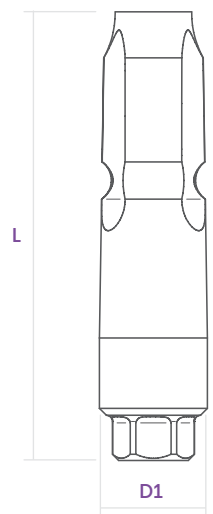

I componenti per la presa d'impronta sono compatibili con tutti i tipi di restauri e sono adatti per le procedure analogiche e digitali, sia a livello implantare che a livello dell'abutment.

L'ampia gamma di soluzioni protesiche consente una pianificazione semplice ma al tempo stesso accurata, dal dente singolo al full-arch.





Transfer & Analoghi

Cucchiaio Aperto		L	D1	Codice Art.
	RS Transfer a Cucchiaio Aperto Slim - Short	13.7	5.5	RS3510
	RS Transfer a Cucchiaio Aperto Slim - Long	17.7	5.5	RS3514
	RS Transfer a Cucchiaio Aperto - Short	13.7	6.3	RS4510
	RS Transfer a Cucchiaio Aperto - Long	17.7	6.3	RS4514

Cucchiaio Chiuso		L	D1	Codice Art.
	RS Transfer a Cucchiaio Chiuso Slim - Short	10.7	3.5	RS5109
	RS Transfer a Cucchiaio Chiuso Slim- Long	14.7	3.5	RS5113
	RS Transfer a Cucchiaio Chiuso - Short	10.7	4.5	RS5209
	RS Transfer a Cucchiaio Chiuso - Long	14.7	4.5	RS5213





Analogo		L	D1	Codice Art.
	RS Analogo Impianto Esagono Interno	12.6	3.7	RS5737

Viti Transfer		L	∅	Codice Art.
	Vite Transfer a Cucchiaio Aperto Short	25	3.1	RS3428
	Vite Transfer a Cucchiaio Aperto Long	29	3.1	RS3429
	Vite Transfer a Cucchiaio Chiuso Short	16.5	3.1	RS5126
	Vite Transfer a Cucchiaio Chiuso Long	20.5	3.1	RS5127

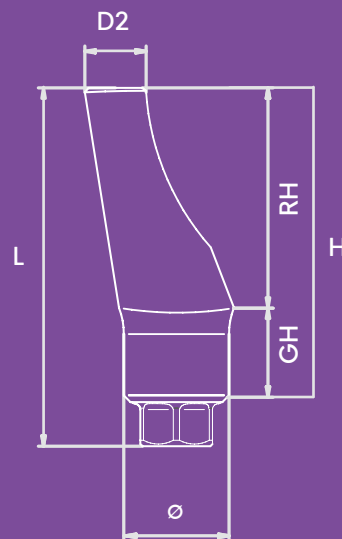



Protesi Cementata

Torque raccomandato 35(Ncm)



Abutment	L	Ø	D2	H	GH	RH	Codice Art.
 RS Abutment Dritto Estetico	9.2	4.5	3	7.5	1	6.5	RS0010
	10.2	4.5	3	8.5	2	6.5	RS0011
	11.2	4.5	3	9.5	3	6.5	RS0012
 RS Abutment Dritto - Senza Spalla	10.4	4.5	3.5	8.5	1	7.5	RS3800
	10.3	4.5	3	8.7	1	7.7	RS3801
 RS Abutment Dritto 2 mm RS Abutment Dritto 3 mm RS Abutment Dritto 4 mm RS Abutment Dritto 5 mm	11.3	4.5	3	9.7	2	7.7	RS3802
	12.3	4.5	3	10.7	3	7.7	RS3803
	13.3	4.5	3	11.7	4	7.7	RS3804
	14.3	4.5	3	12.7	5	7.7	RS3805
 RS Abutment Dritto Long	14.2	4.5	3.5	12.5	1.5	11	RS3811
 RS Abutment profilo Wide	10.5	4.5	4.5	8.9	1.9	7	RS3890

Utilizzare con driver protesico esagonale da 1.27.
Vite RS 3400 inclusa.

Abutment	L	∅	D2	H	GH	RH	Codice Art.	
	RS Abutment Slim (vite RS3402 inclusa)	5.3	3.9	3.3	3.6	0.6	3	RS3903
	RS Abutment Slim (vite RS3402 inclusa)	7.9	3.9	3.3	6.2	0.6	5.6	RS3906
	RS Abutment Slim (vite RS3402 inclusa)	10.4	3.9	3.3	8.6	0.6	8	RS3908
	RS Abutment Angolato 15° (vite RS3480 inclusa)	10.5	4.7	2.6	8.8	1.6	7.2	RS4015
	RS Abutment Angolato 15° Long (vite RS3480 inclusa)	13.1	4.68	1.8	11.5	1.5	10	RS4016
	RS Abutment Angolato Slim 15° 1 mm - Senza Spalla (vite RS3402 inclusa)	10.0	3.8	2.2	8.4	1	7.4	RS4017
	RS Abutment Angolato Slim 15° 2 mm - Senza Spalla (vite RS3402 inclusa)	11.0	3.8	2.2	9.4	2	7.4	RS4018
	RS Abutment Angolato Slim 15° 3 mm - Senza Spalla (vite RS3402 inclusa)	12.0	3.8	2.2	10.4	3	7.4	RS4019
	RS Abutment Angolato 25° (vite RS3480 inclusa)	10.6	4.7	2.5	9	2	7	RS4025
	RS Abutment Angolato 35° (vite RS3480 inclusa)	11.5	4.9	3.3	10	2	8	RS4035
	RS Abutment Estetico Angolato 15° 1 mm (vite RS3480 inclusa)	10.0	4.6	2.3	8.3	1	7.3	RS4115
	RS Abutment Estetico Angolato 15° 2 mm (vite RS3480 inclusa)	11.0	4.6	2.3	9.3	2	7.3	RS4117
	RS Abutment Estetico Angolato 15° 3 mm (vite RS3480 inclusa)	12.0	4.6	2.3	10.3	3	7.3	RS4119



Protesi Provvisoria	L	∅	D2	H	GH	RH	Codice Art.	
	RS Abutment Titanio Cilindrico Dritto Anti-Rotazionale	11.5	4.5	3.2	9.9	2	7.9	RS3411
	RS Abutment Titanio Cilindrico Dritto Rotazionale	11.5	4.5	3.2	9.9	2	7.9	RS3422

Utilizzare con driver protesico esagonale da 1.27.
Vite RS3400 inclusa.

Protesi Avvitata Abutment Calcinabili

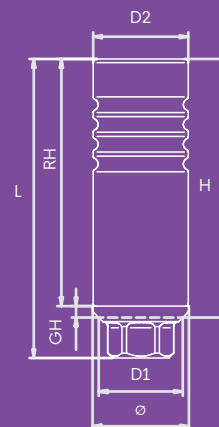
Torque raccomandato 35(Ncm)



Abutment Calcinabili		L	∅	D1	D2	H	GH	RH	Codice Art.
	RS Abutment Cromo Cobalto/Plastica Anti-Rotazionale (vite RS3402 inclusa)	12.1	3.9	3.4	3.9	10.5	0.5	10.0	RS3094
	RS Abutment Cromo Cobalto/Plastica Rotazionale (vite RS3402 inclusa)	12.1	3.9	3.4	3.9	10.5	0.5	10.0	RS3100
	RS Calcinabile Standard Anti-Rotazionale (vite RS3400 inclusa)	10.5	4.5	3.4	3.5	8.9	2.0	6.9	RS5030
	RS Calcinabile Standard Rotazionale (vite RS3400 inclusa)	10.5	4.5	3.4	3.5	8.9	1.0	7.9	RS5050

Viti		L	∅	D1	D2	H	GH	RH	Codice Art.
	RS Vite Protesica	9.5	2.1	-	2.1	-	-	-	RS3400
	RS Vite Protesica Short	8.2	2.1	-	2.1	-	-	-	RS3402
	RS Vite per Abutment Angolato	8.2	2.4	-	2.4	-	-	-	RS3480

CAD CAM

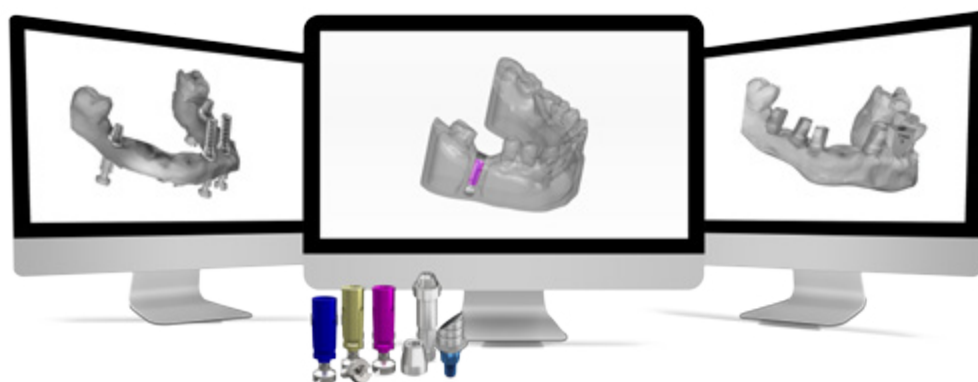

I componenti CAD - CAM e le librerie digitali consentono al Clinico e al Tecnico di creare manufatti protesici di alto livello su impianti Adin, secondo i più attuali protocolli di workflow digitale.

L'ampia gamma di componenti disponibili risponde a qualsiasi esigenza protesica, dal dente singolo a casi di edentulia parziale o totale.

Scan Body per impianto

Scan body | Per Scanner Intra-orale e da laboratorio

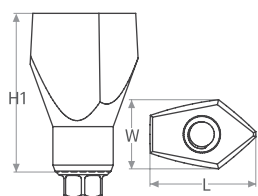

	RS Scan Body 7mm	RS Scan Body 10mm
Codice Art.	RS0088	RS0089
Vite di Ritenzione inclusa	RS3400 	RS3425
Materiale	TI 6Al 4V ELI	TI 6Al 4V ELI
Misure	H1: 7 mm W: 4.3 mm L: 6.7 mm	H1: 10 mm W: 4.4 mm L: 6.8 mm

Impronta Digitale	H	D1	Codice Art.	Vite di Ritenzione
	10	3.75	RS1000	 RS1002 Avvitare con driver da 1.27 mm

Ti Base

Anti-Rotazionale

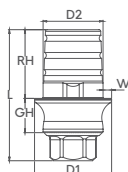

		RH	GH	D1	D2	L	W
TB04411	Ti Base RS Abutment, RH 4mm GH 1mm Anti-Rotazionale	4	1	4.5	3.5	6.65	0.5
TB04421	Ti Base RS Abutment, RH 4mm GH 2mm Anti-Rotazionale	4	2	4.5	3.5	7.65	0.5
TB04431	Ti Base RS Abutment, RH 4mm GH 3mm Anti-Rotazionale	4	3	4.5	3.5	8.65	0.5
TB04441	Ti Base RS Abutment, RH 4mm GH 4mm Anti-Rotazionale	4	4	4.5	3.5	9.65	0.5
TB04611	Ti Base RS Abutment, RH 6mm GH 1mm Anti-Rotazionale	6	1	4.5	3.5	8.65	0.5
TB04621	Ti Base RS Abutment, RH 6mm GH 2mm Anti-Rotazionale	6	2	4.5	3.5	9.65	0.5
TB04631	Ti Base RS Abutment, RH 6mm GH 3mm Anti-Rotazionale	6	3	4.5	3.5	10.65	0.5
TB04641	Ti Base RS Abutment, RH 6mm GH 4mm Anti-Rotazionale	6	4	4.5	3.5	11.65	0.5
TB04811	Ti Base RS Abutment, RH 8mm GH 1mm Anti-Rotazionale	8	1	4.5	3.5	10.65	0.5
TB04821	Ti Base RS Abutment, RH 8mm GH 2mm Anti-Rotazionale	8	2	4.5	3.5	11.65	0.5
TB04831	Ti Base RS Abutment, RH 8mm GH 3mm Anti-Rotazionale	8	3	4.5	3.5	12.65	0.5
TB04841	Ti Base RS Abutment, RH 8mm GH 4mm Anti-Rotazionale	8	4	4.5	3.5	13.65	0.5

Anti-Rotazionale Wide

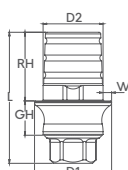

		RH	GH	D1	D2	L	W
TB04411W	Ti Base RS Abutment, RH 4mm GH 1mm Anti-Rotazionale Wide	4	1	5.5	3.5	6.65	1
TB04421W	Ti Base RS Abutment, RH 4mm GH 2mm Anti-Rotazionale Wide	4	2	5.5	3.5	7.65	1
TB04431W	Ti Base RS Abutment, RH 4mm GH 3mm Anti-Rotazionale Wide	4	3	5.5	3.5	8.65	1
TB04441W	Ti Base RS Abutment, RH 4mm GH 4mm Anti-Rotazionale Wide	4	4	5.5	3.5	9.65	1
TB04611W	Ti Base RS Abutment, RH 6mm GH 1mm Anti-Rotazionale Wide	6	1	5.5	3.5	8.65	1
TB04621W	Ti Base RS Abutment, RH 6mm GH 2mm Anti-Rotazionale Wide	6	2	5.5	3.5	9.65	1
TB04631W	Ti Base RS Abutment, RH 6mm GH 3mm Anti-Rotazionale Wide	6	3	5.5	3.5	10.65	1
TB04641W	Ti Base RS Abutment, RH 6mm GH 4mm Anti-Rotazionale Wide	6	4	5.5	3.5	11.65	1
TB04811W	Ti Base RS Abutment, RH 8mm GH 1mm Anti-Rotazionale Wide	8	1	5.5	3.5	10.65	1
TB04821W	Ti Base RS Abutment, RH 8mm GH 2mm Anti-Rotazionale Wide	8	2	5.5	3.5	11.65	1
TB04831W	Ti Base RS Abutment, RH 8mm GH 3mm Anti-Rotazionale Wide	8	3	5.5	3.5	12.65	1
TB04841W	Ti Base RS Abutment, RH 8mm GH 4mm Anti-Rotazionale Wide	8	4	5.5	3.5	13.65	1

Rotazionale

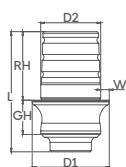

		RH	GH	D1	D2	L	W
TB04412	Ti Base RS Abutment, RH 4mm GH 1mm Rotazionale	4	1	4.5	3.5	6	0.5
TB04422	Ti Base RS Abutment, RH 4mm GH 2mm Rotazionale	4	2	4.5	3.5	7	0.5
TB04432	Ti Base RS Abutment, RH 4mm GH 3mm Rotazionale	4	3	4.5	3.5	8	0.5
TB04442	Ti Base RS Abutment, RH 4mm GH 4mm Rotazionale	4	4	4.5	3.5	9	0.5
TB04612	Ti Base RS Abutment, RH 6mm GH 1mm Rotazionale	6	1	4.5	3.5	8	0.5
TB04622	Ti Base RS Abutment, RH 6mm GH 2mm Rotazionale	6	2	4.5	3.5	9	0.5
TB04632	Ti Base RS Abutment, RH 6mm GH 3mm Rotazionale	6	3	4.5	3.5	10	0.5
TB04642	Ti Base RS Abutment, RH 6mm GH 4mm Rotazionale	6	4	4.5	3.5	11	0.5
TB04812	Ti Base RS Abutment, RH 8mm GH 1mm Rotazionale	8	1	4.5	3.5	10	0.5
TB04822	Ti Base RS Abutment, RH 8mm GH 2mm Rotazionale	8	2	4.5	3.5	11	0.5
TB04832	Ti Base RS Abutment, RH 8mm GH 3mm Rotazionale	8	3	4.5	3.5	12	0.5
TB04842	Ti Base RS Abutment, RH 8mm GH 4mm Rotazionale	8	4	4.5	3.5	13	0.5

Rotazionale Wide

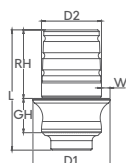

		RH	GH	D1	D2	L	W
TB04412W	Ti Base RS Abutment, RH 4mm GH 1mm Rotazionale Wide	4	1	5.5	3.5	6	1
TB04422W	Ti Base RS Abutment, RH 4mm GH 2mm Rotazionale Wide	4	2	5.5	3.5	7	1
TB04432W	Ti Base RS Abutment, RH 4mm GH 3mm Rotazionale Wide	4	3	5.5	3.5	8	1
TB04442W	Ti Base RS Abutment, RH 4mm GH 4mm Rotazionale Wide	4	4	5.5	3.5	9	1
TB04612W	Ti Base RS Abutment, RH 6mm GH 1mm Rotazionale Wide	6	1	5.5	3.5	8	1
TB04622W	Ti Base RS Abutment, RH 6mm GH 2mm Rotazionale Wide	6	2	5.5	3.5	9	1
TB04632W	Ti Base RS Abutment, RH 6mm GH 3mm Rotazionale Wide	6	3	5.5	3.5	10	1
TB04642W	Ti Base RS Abutment, RH 6mm GH 4mm Rotazionale Wide	6	4	5.5	3.5	11	1
TB04812W	Ti Base RS Abutment, RH 8mm GH 1mm Rotazionale Wide	8	1	5.5	3.5	10	1
TB04822W	Ti Base RS Abutment, RH 8mm GH 2mm Rotazionale Wide	8	2	5.5	3.5	11	1
TB04832W	Ti Base RS Abutment, RH 8mm GH 3mm Rotazionale Wide	8	3	5.5	3.5	12	1
TB04842W	Ti Base RS Abutment, RH 8mm GH 4mm Rotazionale Wide	8	4	5.5	3.5	13	1

Sistema ASC

Canale vite angolato



La soluzione con canale vite angolato (ASC) offre un approccio innovativo per i restauri dentali. Il sistema ASC permette di spostare strategicamente, con una emergeza linguale/palatale, il foro di accesso della vite, ottimizzandone sia la funzionalità che l'estetica. Con una eccellente integrazione digitale e attraverso l'utilizzo di driver specifici, il sistema ASC migliora la precisione e la predicibilità dei restauri implantari.

Questo approccio è un significativo passo in avanti verso un'odontoiatria votata al rispetto della funzionalità e dell'estetica, garanzia di soddisfazione da parte del paziente.

I TiBase per canale vite angolato di Adin hanno altezze gengivali da 1 a 3 mm per ciascuna piattaforma implantare e consentono un'angolazione fino a 20 gradi.

Driver ASC			D1	D2	L	L2
	RP6401	Driver manuale per vite foro angolato Star - Short 23.4 L	9.4	1.4	23.4	9.0
	RP6402	Driver manuale per vite foro angolato Star - Long 28.4 L	9.4	1.4	28.4	14.0
	RP6403	Driver da cricchetto per vite foro angolato Star - Short 17.0 L	7.0	1.4	17.0	11.0
	RP6404	Driver da cricchetto per vite foro angolato Star - Long 22.0 L	7.0	1.4	22.0	16.0
	RP6405	Driver da contrangolo per vite foro angolato Star - Extra Short 20.0 L	2.35	1.4	20.0	7.0
	RP6406	Driver da contrangolo per vite foro angolato Star - Short 25.0 L	2.35	1.4	25.0	12.0
	RP6407	Driver da contrangolo per vite foro angolato Star - Long 30.0 L	2.35	1.4	30.0	17.0

Ti Base

Anti-Rotazionale Angolato

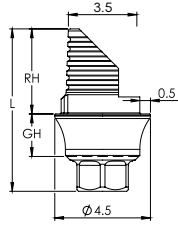

		RH	GH	D1	D2	L	W
TB04413	Ti Base RS Abutment, RH 4mm GH 1mm Anti-Rotazionale Angolato	4	1	4.5	3.5	6.65	0.5
TB04423	Ti Base RS Abutment, RH 4mm GH 2mm Anti-Rotazionale Angolato	4	2	4.5	3.5	7.65	0.5
TB04433	Ti Base RS Abutment, RH 4mm GH 3mm Anti-Rotazionale Angolato	4	3	4.5	3.5	8.65	0.5
TB04613	Ti Base RS Abutment, RH 6mm GH 1mm Anti-Rotazionale Angolato	6	1	4.5	3.5	8.65	0.5
TB04623	Ti Base RS Abutment, RH 6mm GH 2mm Anti-Rotazionale Angolato	6	2	4.5	3.5	9.65	0.5
TB04633	Ti Base RS Abutment, RH 6mm GH 3mm Anti-Rotazionale Angolato	6	3	4.5	3.5	10.65	0.5
TB04813	Ti Base RS Abutment, RH 8mm GH 1mm Anti-Rotazionale Angolato	8	1	4.5	3.5	10.65	0.5
TB04823	Ti Base RS Abutment, RH 8mm GH 2mm Anti-Rotazionale Angolato	8	2	4.5	3.5	11.65	0.5
TB04833	Ti Base RS Abutment, RH 8mm GH 3mm Anti-Rotazionale Angolato	8	3	4.5	3.5	12.65	0.5

Anti-Rotazionale Angolato Wide

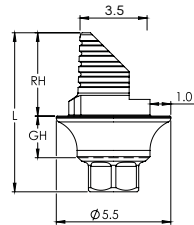

		RH	GH	D1	D2	L	A	W
TB04413W	Ti Base RS Abutment, RH 4mm GH 1mm Anti-Rotazionale Angolato Wide	4	1	5.5	3.5	6.65	45	1
TB04423W	Ti Base RS Abutment, RH 4mm GH 2mm Anti-Rotazionale Angolato Wide	4	2	5.5	3.5	7.65	45	1
TB04433W	Ti Base RS Abutment, RH 4mm GH 3mm Anti-Rotazionale Angolato Wide	4	3	5.5	3.5	8.65	45	1
TB04613W	Ti Base RS Abutment, RH 6mm GH 1mm Anti-Rotazionale Angolato Wide	6	1	5.5	3.5	8.65	35	1
TB04623W	Ti Base RS Abutment, RH 6mm GH 2mm Anti-Rotazionale Angolato Wide	6	2	5.5	3.5	9.65	35	1
TB04633W	Ti Base RS Abutment, RH 6mm GH 3mm Anti-Rotazionale Angolato Wide	6	3	5.5	3.5	10.65	35	1
TB04813W	Ti Base RS Abutment, RH 8mm GH 1mm Anti-Rotazionale Angolato Wide	8	1	5.5	3.5	10.65	25	1
TB04823W	Ti Base RS Abutment, RH 8mm GH 2mm Anti-Rotazionale Angolato Wide	8	2	5.5	3.5	11.65	25	1
TB04833W	Ti Base RS Abutment, RH 8mm GH 3mm Anti-Rotazionale Angolato Wide	8	3	5.5	3.5	12.65	25	1

C-Type Ti Base | Per ulteriori informazioni su prodotto e utilizzo fare riferimento alle IFU028

Anti-Rotazionale

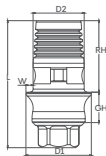

		RH	GH	D1	D2	L	W	Post
TB04414	C-Type Ti Base RS Abutment, GH 1mm Anti-Rotazionale	4.7	1	4.3	3.36	7.35	0.5	Large
TB04424	C-Type Ti Base RS Abutment, GH 2mm Anti-Rotazionale	4.7	2	4.3	3.36	8.35	0.5	Large
TB04434	C-Type Ti Base RS Abutment, GH 3mm Anti-Rotazionale	4.7	3	4.3	3.36	9.35	0.5	Large
TB04444	C-Type Ti Base RS Abutment, GH 4mm Anti-Rotazionale	4.7	4	4.3	3.36	10.35	0.5	Large

Ti Blank

| Per Medentika PreFace® Holder

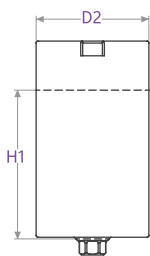

RS Ti Pre Milled
MDTK Abutment Blank
Ø 11.5mm



RS Ti Pre Milled
MDTK Abutment Blank
Ø 15.8mm



Codice Art.	RS1411	RS1415
Vite di Ritenzione inclusa	RS3402	RS3402
Misure	H1: 15.2mm D2: Ø 11.5 mm	H1: 15.2mm D2: Ø 15.8 mm
Utilizzo	Abutment customizzato per elemento singolo	Abutment customizzato per elemento singolo

RS Vite per TiBase dritti e Ti Blank



Codice Art. RS3402

RS Vite per TiBase angolati



Codice Art. RS3405

TMA™ - Multi Unit

Torque raccomandato 35 (Ncm)

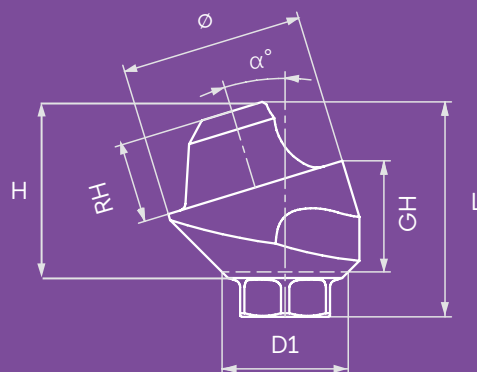

Il sistema di abutment transmucosi TMA™ è indicato per protesi avvitate multipla e può essere utilizzato in combinazione con una realizzazione protesica tradizionale.

Serve per elevare la piattaforma di appoggio della protesi laddove il restauro a livello dell'impianto non sia indicato oppure non sia realizzabile a causa della profondità o angolazione dell'impianto stesso.

Il sistema TMA™ nasce inoltre per consentire un migliore accesso protesico su impianti inclinati in arcate totalmente o parzialmente edentule ed in particolare nel caso di impianti inclinati con protesi full-arch "all-on-x".

Il Sistema TMA™ include abutment dritti e angolati (17°, 30°, 45°, 52°, 60°), con ingaggio ad esagono interno in diverse altezze e indice esagonale. Ogni abutment viene fornito completo di portatore che ne agevola il prelievamento e posizionamento.

TMA dritti		L	Ø	D1	H	GH	RH	Codice Art.
	RS Abutment Transmucoso Dritto 1mm	3.7	4.9	3.4	3.1	1	2.1	RS3731
	RS Abutment Transmucoso Dritto 2mm	4.7	4.9	3.4	4.1	2	2.1	RS3732
	RS Abutment Transmucoso Dritto 3mm	5.7	4.9	3.4	5.1	3	2.1	RS3733
	RS Abutment Transmucoso Dritto 4mm	6.7	4.9	3.4	6.1	4	2.1	RS3729
	RS Abutment Transmucoso Dritto 5mm	7.7	4.9	3.4	7.1	5	2.1	RS3730

Viti incluse nella confezione		L	Ø	Codice Art.
	RS Vite di Ritenzione per TMA 1mm	7.8	3.1	RS3406
	RS Vite di Ritenzione per TMA 2mm	8.8	3.1	RS3407
	RS Vite di Ritenzione per TMA 3mm	9.8	3.1	RS3408
	RS Vite di Ritenzione per TMA 4mm	10.8	3.1	RS3409
	RS Vite di Ritenzione per TMA 5mm	11.8	3.1	RS3412





TMA angolati		L	∅	D1	H	GH	RH	Codice Art.
	RS Abutment Transmucoso Angolato 17° 2mm	5.17	4.9	3.4	-	2	2.1	RS3734
	RS Abutment Transmucoso Angolato 17° 3mm	6.05	4.9	3.4	-	3	2.1	RS3737
	RS Abutment Transmucoso Angolato 30° 3mm	5.7	4.9	3.4	-	3	2.1	RS3735
	RS Abutment Transmucoso Angolato 30° 4mm	6.5	4.9	3.4	-	4	2.1	RS3738
	RS Abutment Transmucoso Angolato 45° 4mm	5.94	4.9	3.4	-	4	2.1	RS3736
	RS Abutment Transmucoso Angolato 52° 5mm	5.0	4.9	3.4	-	5	2.1	RS3739
	RS Abutment Transmucoso Angolato 60° 5mm	7.5	4.9	3.4	-	5	2.1	RS3740

Vite RS3403 inclusa nella confezione

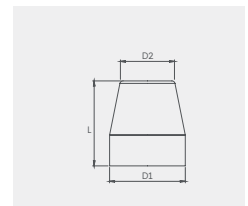

Cappetta di Guarigione		L	D1	D2	Codice Art.
	TMA Cappetta di Guarigione (Vite RS3404 inclusa nella confezione)	5.5	4.9	3.5	RS5005
		7.0	4.9	3.5	RS5003



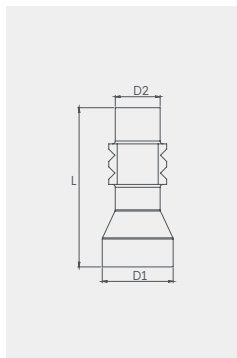

Viti		L	∅	Codice Art.
	RS Vite di Ritenzione per TMA Angolato	6.1	2.4	RS3403
	TMA Vite Protetica 15 (Ncm)	4.1	2.1	RS3404

Protesi per TMA™

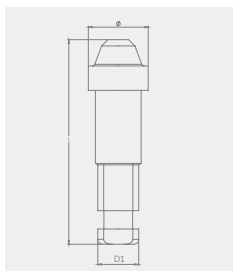

TMA Transfer		L	D1	D2	Codice Art.
	TMA Transfer per Impronta a Cucchiaino Aperto (Vite RS5008 inclusa nella confezione)	11.0	4.9	3.1	RS5006
	TMA Transfer per Impronta a Cucchiaino Chiuso (Vite RS5009 inclusa nella confezione)	8.0	4.9	4.1	RS5011



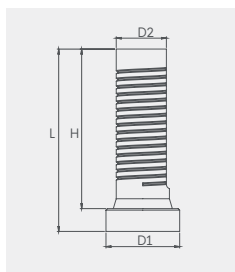

TMA Analogo		L	D1	Codice Art.
	TMA Analogo	16.8	4.9	RS5004



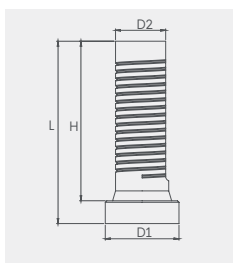

TMA Abutment Calcinabile		L	D1	D2	H	Codice Art.
	TMA Abutment Calcinabile (Vite RS3404 inclusa nella confezione)	12.0	4.9	3.3	10.5	RS5001





TMA Abutment Provvisorio		L	D1	D2	H	Codice Art.
	TMA Abutment Provvisorio in Titanio (Vite RS3404 inclusa nella confezione)	12.0	4.9	3.5	10.5	RS4900

TMA Viti		L	∅	Codice Art.
	TMA Vite per Transfer a Cucchiaino Aperto	14	2.1	RS5008
	TMA Vite per Transfer a Cucchiaino Chiuso	6.8	2.5	RS5009

Protesi Digitale per TMA™

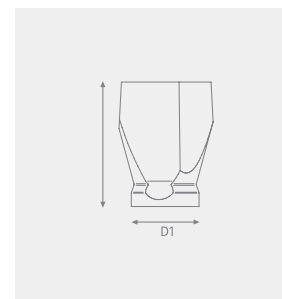

TMA Scan Body		L	D1	Codice Art.
	TMA Scan Body (Vite TM0001 inclusa nella confezione)	6.0	4.9	TM0006
		9.0	4.9	TM0009

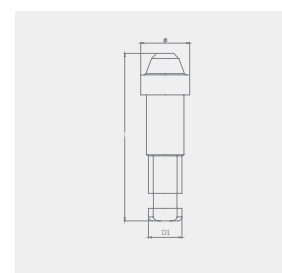

TMA Analogo Modello Digitale		L	D1	D2	Codice Art.
	TMA Analogo Modello Digitale	12.0	4.9	3.35	RS1001

Utilizzare con driver protesico esagonale da 1.27.



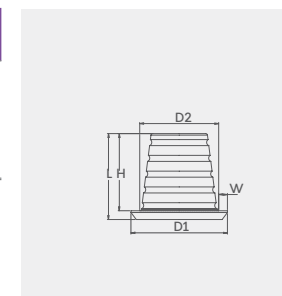

TMA Abutment da incollaggio		L	D1	D2	H	W	Codice Art.
	TMA Abutment da incollaggio	4.9	4.9	3.9	3.4	0.5	TM0010
	TMA Abutment da incollaggio, low profile	4.9	5.5	4.5	4.4	0.5	TM0011

Vite TM0001 inclusa nella confezione

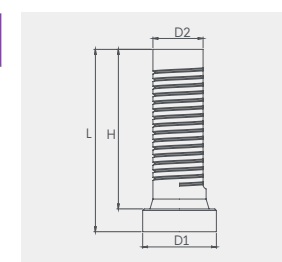

TMA Abutment Provvisorio		L	D1	D2	H	Codice Art.
	TMA Abutment Provvisorio in Titanio (Vite RS3404 inclusa nella confezione)	12.0	4.9	3.5	10.5	RS4900



TMA Viti		Codice Art.
	TMA Vite Scan Body	TM0001

Single TMA™

Torque raccomandato 35(Ncm)

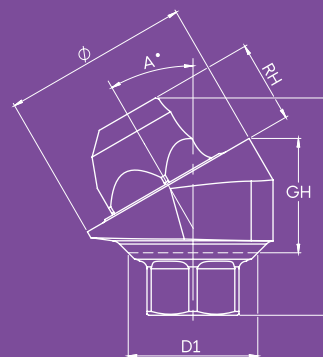

Il sistema STMA (Single Trans Mucosal Abutment) utilizza tutti i vantaggi della linea TMA MultiUnit, consentendo al contempo la precisione e la flessibilità della protesi avvitata su singolo elemento. Il sistema contempla la possibilità di restauri protesici full digital, offrendo una linea di soluzioni esclusive, moderne e complete tale da garantire al professionista la scelta più adeguata per l'ottenimento del miglior risultato estetico.

STMA dritti		L	D1	Ø	GH	RH	Codice Art.
	RS Abutment Dritto Single TMA 1mm	3.7	3.4	4.9	1.0	2.1	RS3731S
	RS Abutment Dritto Single TMA 2mm	4.7	3.4	4.9	2.0	2.1	RS3732S
	RS Abutment Dritto Single TMA 3mm	5.7	3.4	4.9	3.0	2.1	RS3733S
	RS Abutment Dritto Single TMA 4mm	6.7	3.4	4.9	4.0	2.1	RS3729S
	RS Abutment Dritto Single TMA 5mm	7.7	3.4	4.9	5.0	2.1	RS3730S

Viti incluse nella confezione		L	Ø	Codice Art.
	RS Vite di Ritenzione per TMA 1mm	7.8	3.1	RS3406
	RS Vite di Ritenzione per TMA 2mm	8.8	3.1	RS3407
	RS Vite di Ritenzione per TMA 3mm	9.8	3.1	RS3408
	RS Vite di Ritenzione per TMA 4mm	10.8	3.1	RS3409
	RS Vite di Ritenzione per TMA 5mm	11.8	3.1	RS3412

STMA Angolati		L	D1	∅	GH	RH	Codice Art.
	RS Abutment Angolato Single TMA 17° 2mm	5.2	3.4	4.9	2.0	2.15	RS3734S
	RS Abutment Angolato Single TMA 30° 3mm	5.7	3.4	4.9	3.0	2.15	RS3735S
	RS Abutment Angolato Single TMA 17° 3mm	6.2	3.4	4.9	3.0	2.15	RS3737S
	RS Abutment Angolato Single TMA 30° 4mm	6.5	3.4	4.9	4.0	2.15	RS3738S

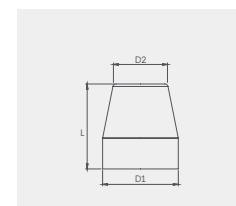

Vite RS3403 inclusa nella confezione

STMA Cappetta di Guarigione		L	D1	D2	Codice Art.
	Single TMA Cappetta di Guarigione	5.5	4.9	3.5	RS5005S

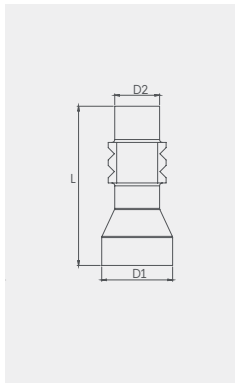

Vite RS3404 inclusa nella confezione



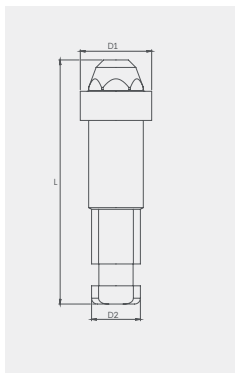

STMA Transfer		L	D1	D2	Codice Art.
	Single TMA Transfer per impronta a Cucchiaino Aperto (Vite RS5008 inclusa nella confezione)	11.0	4.9	3.1	RS5006S
	Single TMA Transfer per impronta a Cucchiaino Chiuso (Vite RS5009 inclusa nella confezione)	8.0	4.9	4.1	RS5011S



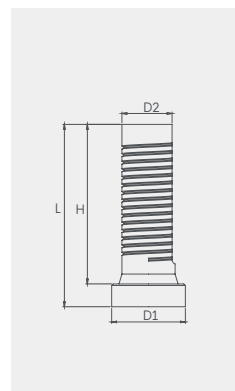

STMA Analogo		L	D1	Codice Art.
	Single TMA Analogo	16.75	4.9	RS5004S



STMA Abutment		L	D1	D2	H	Codice Art.
	Single TMA Abutment Provvisorio in Titanio (Vite RS3404 inclusa nella confezione)	12.0	4.9	3.5	10.5	RS4900S
	Single TMA Abutment Calcinabile con Vite Protetica (Vite RS3404 inclusa nella confezione)	12.0	4.9	3.5	10.35	RS5001S

Protesi Digitale per Single TMA™

STMA Scan Body		L	D1	Codice Art.
	Single TMA Scan Body (Vite TM0001 inclusa nella confezione)	6.0	4.9	TM0006S
		9.0	4.9	TM0009S

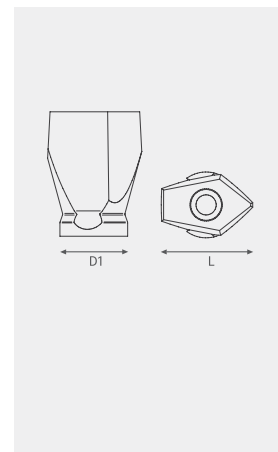

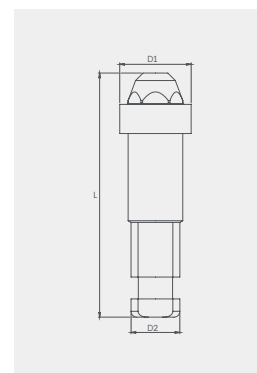

STMA Analogo Modello Digitale		L	D1	D2	Codice Art.
	Single TMA Analogo Modello Digitale	12.0	4.9	3.8	RS1001S

Utilizzare con driver protesico esagonale da 1.27.

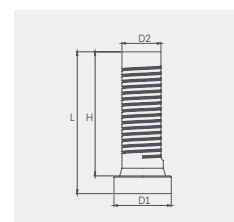

STMA Abutment Provvisorio		L	D1	D2	H	Codice Art.
	Single TMA Abutment Provvisorio in Titanio (Vite RS3404 inclusa nella confezione)	12.0	4.9	3.5	10.5	RS4900S





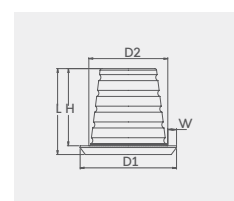

STMA Abutment da incollaggio		L	D1	D2	H	W	Codice Art.
	Single TMA Abutment da incollaggio, low profile (Vite TM0001 inclusa nella confezione)	4.9	5.5	4.5	4.4	0.5	TM0011S

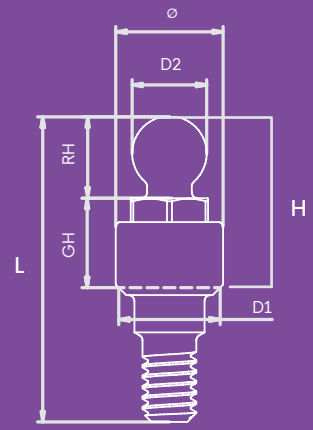

Protesi Overdenture

Torque raccomandato 35(Ncm)



		L	Ø	D1	D2	H	GH	RH	Codice Art.
	Cappetta Bianca per Attacco a sfera (Nylon)	2.6	4.1	-	3.6	-	-	-	RS2660
	Cappetta Rosa Soft per Attacco a sfera (Nylon)	2.6	4.1	-	3.6	-	-	-	RS2662
	Cappetta in Titanio per Attacco a sfera	2.9	4.7	-	4.7	-	-	-	RS2670
	RS Attacco a sfera	7.45	4	3.4	2.5	2.95	0.5	2.45	RS2650
		7.95	4	3.4	2.5	3.45	1	2.45	RS2651
		8.95	4	3.4	2.5	4.45	2	2.45	RS2652
		9.95	4	3.4	2.5	5.45	3	2.45	RS2653
		10.95	4	3.4	2.5	6.45	4	2.45	RS2654
		11.95	4	3.4	2.5	7.45	5	2.45	RS2655
	Analogo Attacco a sfera	16.6	4.0	-	-	-	0.8	2.7	RS5740

Utilizzare con driver protesico esagonale da 1.27.

Grip™

Attacchi per overdenture

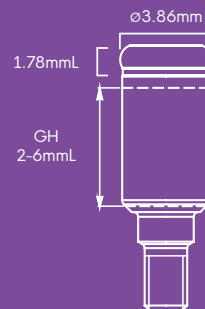
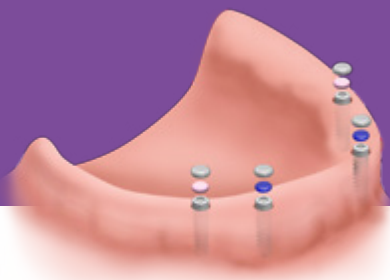

Le protesi overdenture su impianti sono tra le scelte più pratiche per i pazienti che non possono utilizzare restauri fissi. Inoltre, possono rappresentare anche una soluzione provvisoria per i pazienti che attendono il processo di osteointegrazione degli impianti appena inseriti.

Il sistema di attacchi Grip™ rappresenta una risposta versatile, progettata per garantire la massima stabilità della protesi, sia in arcata superiore che inferiore. La vasta gamma di cappette ritentive consente al professionista di individuare la soluzione migliore per ogni singolo caso.

Il sistema di attacchi Grip™ è disponibile per la Connessione a Esagono Interno in un'ampia gamma di altezze gengivali, in modo da garantire una soluzione sicura e affidabile a lungo termine.

Grip™ componenti



Grip™ Abutment

RS3037	Grip RS Abutment 1mm
RS3032	Grip RS Abutment 2mm
RS3033	Grip RS Abutment 3mm
RS3034	Grip RS Abutment 4mm
RS3035	Grip RS Abutment 5mm
RS3036	Grip RS Abutment 6mm



Grip™ per TMA

TM0100

Vite RS3404 inclusa



Grip™ per Bar, M2 thread

RS0101

Cappette ritentive		housing		RS6426
		processing		
		extra light		
		light		
		regular		
		Spaziatore		

Grip™ Cappette ritentive angolazioni estese		housing		RS6427
		processing		
		zero		
		extra light		
		light		
		regular		
		Spaziatore		

Confezioni di vendita

	Cappetta in metallo 4 unità per confezione	RS6413
---	---	--------

			extra light	Grip™ Cappette ritentive 4 unità per confezione	RS6417
			light		RS6418
			regular		RS6419

			zero	Cappette ritentive angolazioni estese 4 unità per confezione	RS6420
			extra light		RS6421
			light		RS6422
			regular		RS6423

Grip™ componenti

	Transfer 4 unità per confezione	RS6414
---	------------------------------------	--------

	Cappette da lab. 4 unità per confezione	RS6415
---	--	--------

	Cappette da lab. 20 unità per confezione	RS6416
--	---	--------

	Grip Analogo 4 unità per confezione	RS2508
---	--	--------

	Spaziatore 4 unità per confezione	RS6424
---	--------------------------------------	--------

Grip™ inseritore	RS6200
------------------	--------



A photograph of three young women with long hair, wearing sunglasses and summer clothing, smiling and posing on a beach. The image is overlaid with a semi-transparent purple circular filter. The text 'Chirurgia Guidata' is centered over the image in a white, sans-serif font.

Chirurgia Guidata

Adinguide™ è stato creato per offrire al professionista la possibilità di espandere l'attività della propria clinica e dare una risposta alle esigenze contemporanee.

I kit di chirurgia guidata Adin sono stati progettati per mettere in pratica procedure semplici e precise, al fine di garantire un posizionamento dell'impianto in totale sicurezza.

L'innovativa tecnologia di irrigazione "ActiveFlow" migliora il raffreddamento del sito implantare in presenza di una dima chirurgica.

Le frese Adinguide sono progettate con canali intagliati che permettono alla soluzione fisiologica di defluire attraverso la boccola per garantire una migliore irrigazione e ridurre il surriscaldamento osseo.

Il nostro kit di frese, dal design esclusivo, è intuitivo e facile da usare in base al diametro e alla lunghezza dell'impianto.

Il mucotomo consente un facile accesso senza lembo e la fresa pilota regolarizza le creste frastagliate.

Frese auto-centranti – gli stop, di diametro 5.5 e 3.3, presenti sulla parte alta delle frese, ingaggiano la boccola prima ancora che l'apice possa toccare l'osso.

Questo sistema garantisce un posizionamento corretto della fresa, oltre che una precisa e accurata osteotomia alla profondità desiderata.

The image displays two Adin surgical kits for guided surgery. The kit on the left is shown from a top-down perspective, with its lid open to reveal a tray containing several drill bits of different sizes and a blue handle. The lid has the 'adin' logo and some text. The kit on the right is shown from a side-on perspective, also with its lid open. It features a more complex design with a handle and a tray containing drill bits. The lid of this kit also has the 'adin' logo and text. Both kits are designed for precision and ease of use in surgical procedures.

59

Kit Chirurgia Guidata

Frese I GSK001



Procedura guidata completa:



Piattaforma Implantare
Esagono interno



GS Tool Kit RS
GSK003



Boccola 5.5mmD
GS0055



GS5055 Mucotomo 5.0mmD, S-5.5



GS0625 Fresa Pilota S-5.5, 2.5/1.8mmDx6.0mml



GS0825 Fresa S-5.5, 2.5/1.8mmDx8.0mml



GS1025 Fresa S-5.5, 2.5/1.8mmDx10.0mml



GS1125 Fresa S-5.5, 2.5/1.8mmDx11.5mml



GS1325 Fresa S-5.5, 2.5/1.8mmDx13.0mml



GS1625 Fresa S-5.5, 2.5/1.8mmDx16.0mml

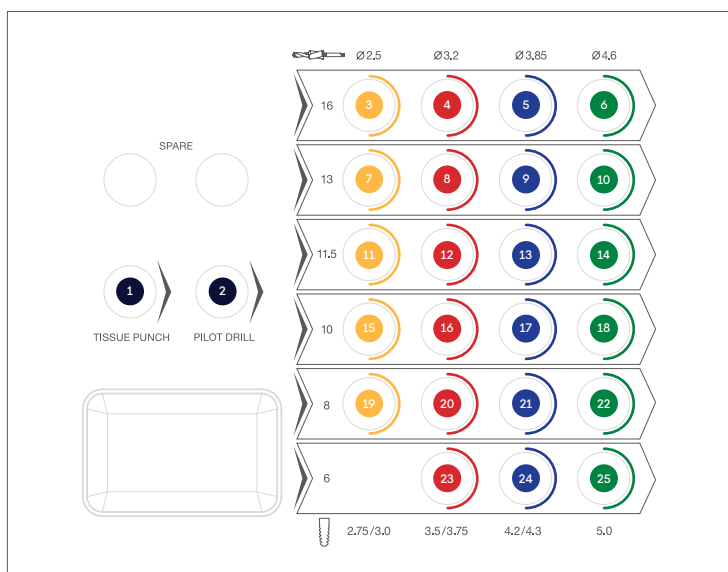

GS0632 Fresa S-5.5, 3.2/2.5mmDx6.25mml



GS0638 Fresa S-5.5, 3.85/3.2mmDx6.25mml



GS0646 Fresa S-5.5, 4.6/3.85mmDx6.25mml



GS0832 Fresa S-5.5, 3.2/2.5mmDx8.0mml



GS0838 Fresa S-5.5, 3.85/3.2mmDx8.0mml



GS0846 Fresa S-5.5, 4.6/3.85mmDx8.0mml



GS1032 Fresa S-5.5, 3.2/2.5mmDx10.0mml



GS1038 Fresa S-5.5, 3.85/3.2mmDx10.0mml



GS1046 Fresa S-5.5, 4.6/3.85mmDx10.0mml



GS1132 Fresa S-5.5, 3.2/2.5mmDx11.5mml



GS1138 Fresa S-5.5, 3.85/3.2mmDx11.5mml



GS1146 Fresa S-5.5, 4.6/3.85mmDx11.5mml



GS1332 Fresa S-5.5, 3.2/2.5mmDx13.0mml



GS1338 Fresa S-5.5, 3.85/3.2mmDx13.0mml



GS1346 Fresa S-5.5, 4.6/3.85mmDx13.0mml



GS1632 Fresa S-5.5, 3.2/2.5mmDx16.0mml



GS1638 Fresa S-5.5, 3.85/3.2mmDx16.0mml



GS1646 Fresa S-5.5, 4.6/3.85mmDx16.0mml

Guided Surgery Kit RS Touareg™ | Strumentario GSK003



Procedura guidata completa:



Piattaforma Implantare
Esagono Interno



GS Kit Frese
GSK001



Boccola 5.5mmD
GS0055

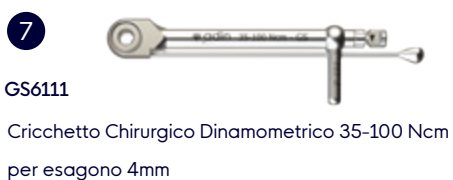
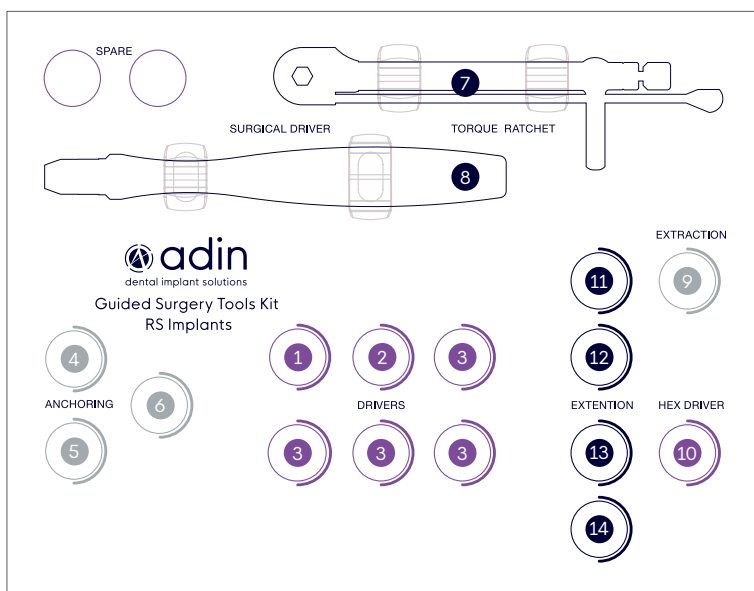

Articoli aggiuntivi

Venduti separatamente

Accessori



2.0mm Boccia per vite di ancoraggio

Codice Art. GS0020



5.5mmD Boccia

Codice Art. GS0055



Pin crestale S-3.3

Codice Art. GS0006



Pin crestale S-5.5

Codice Art. GS0007



2.0D 19mmL Boccia ancoraggio

Codice Art. GS1920

| Opzioni di acquisto (unità per confezione)

Codice Art.	Descrizione	Contenuto Confezione	Unità
GS0006	Pin crestale S-3.3		x 3
GS0007	Pin crestale S-5.5		x 3
GS1920	2.0mmD Boccia ancoraggio		x 3
GS0055	5.5mmD Boccia		x 1
GS0020	2.0mm Boccia per vite di ancoraggio		x 3

Frese opzionali



Frese 18mm



Fresa S-5.5, 2.5/1.8mmDx18.0mmL

Codice Art. GS1825



Fresa S-5.5, 3.2/2.5mmDx18.0mmL

Codice Art. GS1832



Fresa S-5.5, 3.85/3.2mmDx18.0mmL

Codice Art. GS1838



Fresa S-5.5, 4.6/3.85mmDx18.0mmL

Codice Art. GS1846



Connessione Conica Standard

CloseFit™ UNP/NP & RP/WP

Il sistema implantare CloseFit™ offre una connessione conica estremamente stabile, progettata per ridurre al minimo i micromovimenti tra impianto e abutment e la potenziale perdita di osso.

L'impianto CloseFit con nucleo conico presenta un design con solchi coronali, spire trapezoidali a disegno variabile e apice piatto attivo. Gli impianti della linea CloseFit possono essere impiegati con diverse angolazioni in entrambe le arcate e sono particolarmente indicati per il posizionamento sottocrestale fino a 1.0 - 2.0 mm.

La linea implantare CloseFit™ presenta la superficie implantare OsseoFix™ - un trattamento di superficie bioattivo arricchito con fosfato di calcio ad alta purezza, concepito per ottenere un livello ottimale di ruvidità ed elevate proprietà osteoconduttive.

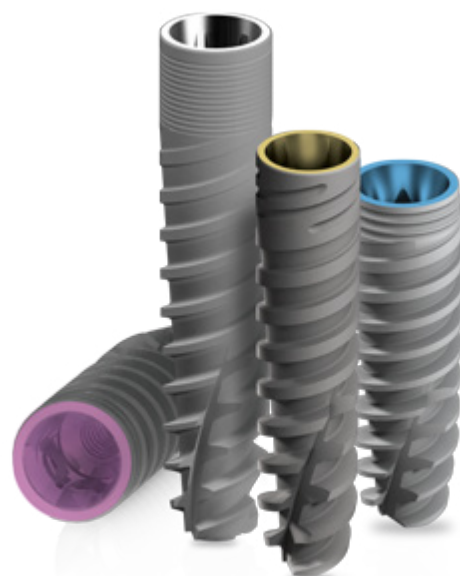



CloseFit™

Narrow & Ultra Narrow

CloseFit™ NP

Piattaforma Narrow

Solchi coronali

Spire trapezoidali
a disegno variabile
doppio passo
2.4mm (2x1.2)

Automaschiante
Osteocondensante
Ridirezionabile in fase
di inserimento

Apice piatto
attivo

CloseFit™ UNP

Piattaforma Ultra Narrow

Micro anelli coronali

Spire trapezoidali
a disegno variabile
triplo passo 3.0mm (3x1)

Ideale per creste
estremamente sottili

Automaschiante
Osteocondensante

Apice piatto
attivo

CloseFit™ - Narrow & Ultra Narrow

CloseFit™ Narrow e Ultra Narrow sono impianti realizzati con piattaforma protesica conica e serraggio a vite. Con design esclusivo e diametro rispettivamente da 3.0 mm e 2.75 mm, rappresentano la soluzione ideale in riabilitazioni di creste sottili e mascellari atrofici, dove consentono di ottenere risultati estetici eccellenti.

Superficie OsseoFix™

Titanio grado 23 (Ti 6Al 4V ELI)

CloseFit™ NP - Piattaforma Narrow	
Lunghezza	Ø 3.0 mm
10 mm	ISPNP1030
11.5 mm	ISPNP1130
13 mm	ISPNP1330
16 mm	ISPNP1630
18 mm	ISPNP1830

CloseFit™ UNP - Piattaforma Ultra Narrow	
Lunghezza	Ø 2.75 mm
10 mm	ISPUNP1027
11.5 mm	ISPUNP1127
13 mm	ISPUNP1327
16 mm	ISPUNP1627
18 mm	ISPUNP1827

Prova di fatica dinamica

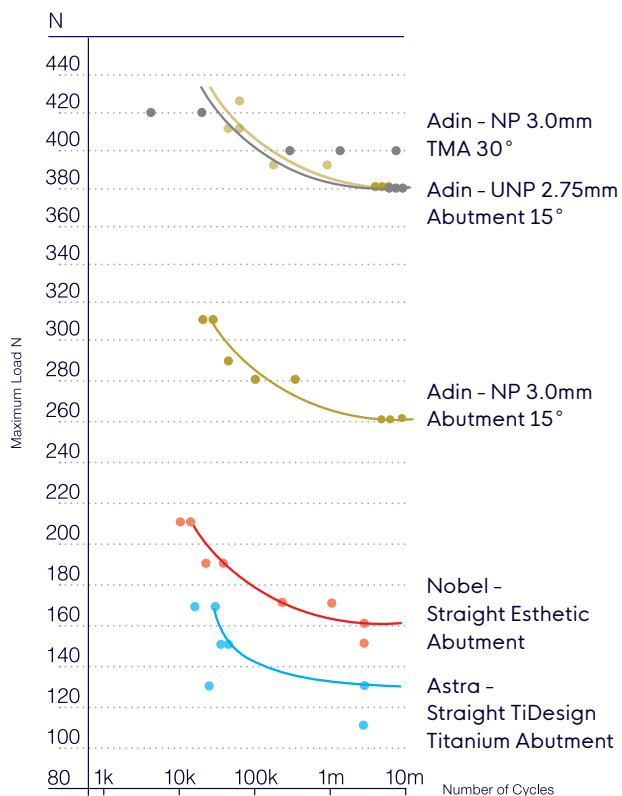

- Fatigue test data points
- Adin's CloseFit™ NP 3.0 mmD + Trans Mucosal Abutment 300
- Adin's CloseFit™ UNP 2.75 mmD + Abutment 150
- Adin's CloseFit™ NP 3.0 mmD + Abutment 150
- NobelActive™ 3.0 - Straight Esthetic Abutment
- Astra Tech 3.0S - Straight TiDesign Titanium Abutment

Riferimenti:

- [1] Gardin C., Ferroni L., Piattelli A., Sivoilella S., Zavan B., Mijiritsky E. "Non-Washed Resorbable Blasting Media (NWRBM) on Titanium Surfaces could Enhance Osteogenic Properties of MSCs through Increase of miRNA196-a And VCAM1." *Stem Cell Rev.* 2016 Oct;12 (552-543):5.
- [2] Coelho, Paulo G., et al. "Biomechanical and histologic evaluation of non-washed resorbable blasting media and alumina-blasted/ acid-etched surfaces." *Clinical oral implants research* -132 :(2012) 23.1 135.
- [3] Lazzara RJ, Porter SS. "Platform switching: a new concept in implant dentistry for controlling postrestorative crestal bone levels. *Int J Periodontics Restorative Dent.* 17-26:9 ;2006.

Note: I dati Nobel e Astra sono stati presi direttamente dalla brochure NobelActive 3.0 di Nobel Biocare. Astra Tech e OsseoSpeec sono marchi di AstraTech Group. NobelActive è un marchio di Nobel Biocare. Tutti i test Adin sono stati condotti prendendo in esame i "worst cases".

Protocollo di foratura NP & UNP

Protocollo di Foratura CloseFit NP Velocità di foratura raccomandata: fino a 1200 rpm

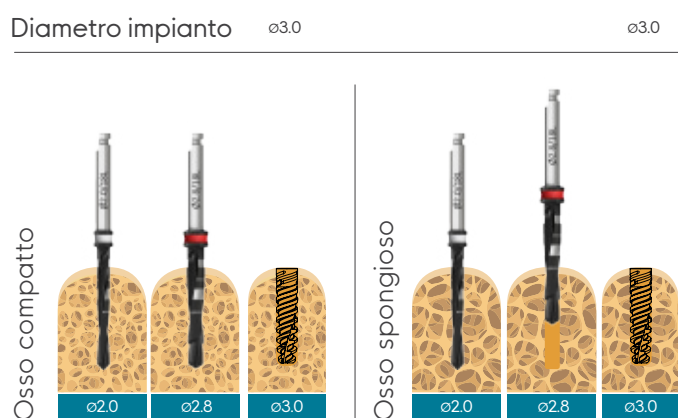

NOTE:

- Le misure sono espresse in mm.
- La fresa effettua una preparazione di 1 mm più profonda rispetto alla lunghezza dell'impianto.
- I prodotti possono essere ordinati separatamente in aggiunta al kit.
- Fresa Step con apice = 1.8mmD.

Protocollo di Foratura CloseFit UNP Velocità di foratura raccomandata: fino a 1200 rpm



NOTE:

- Le misure sono espresse in mm.
- La fresa effettua una preparazione di 1 mm più profonda rispetto alla lunghezza dell'impianto.
- I prodotti possono essere ordinati separatamente in aggiunta al kit.
- Fresa Step con apice = 1.8mmD.

Viti di Guarigione NP & UNP

Torque raccomandato 15(Ncm)

NP CloseFit™ Vite di Guarigione Slim

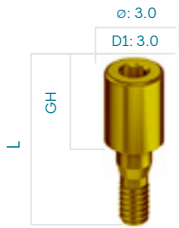

NP0046, GH2/L6.6
NP0047, GH3/L7.6
NP0048, GH4/L8.6
NP0049, GH5/L9.6
NP0050, GH6/L10.6

UNP CloseFit™ Vite di Guarigione Slim



UNP0046, GH2/L6.9
UNP0047, GH3/L7.9
UNP0048, GH4/L8.9
UNP0049, GH5/L9.9
UNP0050, GH6/L10.9

NP CloseFit™ Vite di Guarigione Conica



NP0090, GH2/L6.9
NP0091, GH3/L7.9
NP0092, GH4/L8.9
NP0093, GH5/L9.9
NP0094, GH6/L10.9

UNP CloseFit™ Vite di Guarigione Conica



UNP0090, GH2/L6.9
UNP0091, GH3/L7.9
UNP0092, GH4/L8.9
UNP0093, GH5/L9.9
UNP0094, GH6/L10.9

NP CloseFit™ Vite Tappo Conica



NP0073

UNP CloseFit™ Vite Tappo Conica



UNP0073

NP CloseFit™ Vite di Guarigione

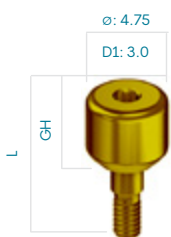

NP0004, GH2/L6.5
NP0008, GH3/L7.5
NP0009, GH4/L8.5
NP0012, GH5/L9.5
NP0013, GH6/L10.5

UNP CloseFit™ Vite di Guarigione



UNP0004, GH2/L7.1
UNP0008, GH3/L8.1
UNP0009, GH4/L9.1
UNP0012, GH5/L10.1
UNP0013, GH6/L11.1

Kit Chirurgico

Composizione RS-NP











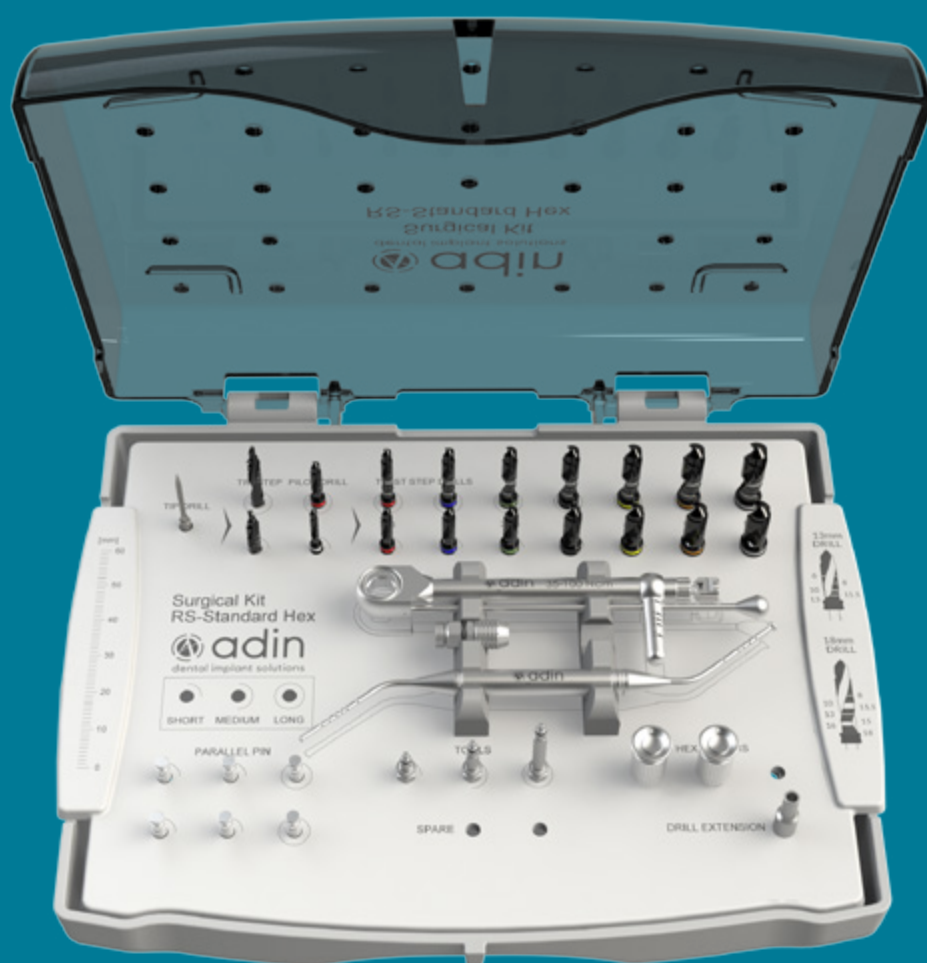









immagine a solo scopo illustrativo



Composizione RS-NP







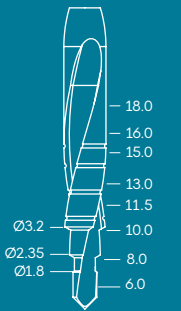

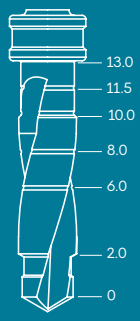

FRESE TWIST STEP 8-18mmL							
Fresa Pilota 2mmD	2.3/ 2.8mmD	2.8/ 3.2mmD	3.2/ 3.6mmD	3.8/ 4.2mmD	4.2/ 4.6mmD	4.8/ 5.2mmD	5.2/ 5.6mmD
							
DL1820	DL1828	DL1832	DL1836	DL1842	DL1846	DL1852	DL1856
1	1	1	1	1	1	1	1

DRIVER IMPLANTARI			DRIVER PROTESICI						
RS Adattatore Esagonale Contrangolo - Medium	RS Adattatore Esagonale Contrangolo - Long	NP 2mm Adattatore Esagonale Contrangolo - Medium	1.27 Driver Esagonale Manuale - Short	1.27 Driver Esagonale Manuale - Medium	1.27 Driver Esagonale Cricchetto - Short	1.27 Driver Esagonale Cricchetto - Long	TMA Driver Esagonale Cricchetto - Long	Driver per Cricchetto Star - Long	Driver per Attacco a pallina
									
RS9026	RS9029	NP0074	RS6095	RS6094	RS6080	RS6082	RS6196	RP0005	RS6090
1	1	1	1	1	1	1	1	1	1

FRESE E ACCESSORI CHIRURGICI						
Fresa di Marcatura	Prolunga per Fresa	Sonda di profondità	Pin di Parallelismo 16	Pin di Parallelismo 11	Cricchetto Dinamometrico 15-35Ncm	Adattatore Driver per Cricchetto
						
RS8032	RS9027	RS6180	RS6155	RS6150	RS6112	RA0050
1	1	1	2	1	1	1

Frese opzionali

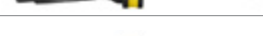
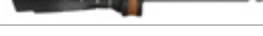
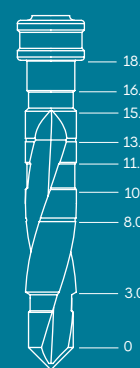
Frese Tri-Step	Ø		Misura	Codice Art.
 <p>Technical drawing of a Tri-Step drill bit showing diameters (Ø3.2, Ø2.35, Ø1.8) and lengths (18.0, 16.0, 15.0, 13.0, 11.5, 10.0, 8.0, 6.0).</p>	1.8-3.2		short	TD1511
	1.8-3.2		long	TD2218

Frese Twist Step	Ø		Colore	Codice Art.
<p>short</p>  <p>Technical drawing of a short Twist Step drill bit showing diameters (13.0, 11.5, 10.0, 8.0, 6.0, 2.0, 0) and lengths (6-13mm).</p> <p>6-13mm</p>	2.0		white	DL1320
	1.8-2.5		purple	DL1325
	2.3-2.8		red	DL1328
	2.8-3.2		blue	DL1332
	3.2-3.6		green	DL1336
	3.8-4.2		black	DL1342
	4.2-4.6		yellow	DL1346
	4.8-5.2		brown	DL1352
	5.2-5.6		grey	DL1356
<p>long</p>  <p>Technical drawing of a long Twist Step drill bit showing diameters (18.0, 16.0, 15.0, 13.0, 11.5, 10.0, 8.0, 3.0, 0) and lengths (8-18mm).</p> <p>8-18mm</p>	1.8-2.5		purple	DL1825

Strumentario Chirurgico supplementare

		Codice Art.
	Cricchetto Chirurgico Dinamometrico 35-100 Ncm	RS6111
	Cricchetto	RS6100
	Cacciavite Chirurgico	RS7001



NP 2mm Driver
Esagonale per
Cricchetto 17mm

NP0006



NP 2mm Driver
Esagonale per
Cricchetto 27mm

NP0005



UNP 2mm Adattatore
Esagonale per
Contrangolo
Short 23.60L

UNP0068



UNP 2mm Adattatore
Esagonale per
Contrangolo
Medium 27.20L

UNP0071



UNP 2mm Adattatore
Esagonale per
Contrangolo - Long
36.00L

UNP0074



NP 2mm Adattatore
Esagonale per
Contrangolo 23.7mm

NP0068



NP 2mm Adattatore
Esagonale per
Contrangolo
27.7mm

NP0071

Strumentario Protесico supplementare

Star (Per TMA angolato/Vite protesica TMA)



Driver per
Cricchetto
Star-Short

RP0065



Driver
Manuale
Star-Long

RP0004



Driver
Manuale
Star-Short

RP0064



Driver per
Contrangolo Star 25mm

RP0018



Driver per
Contrangolo Star 30mm

RP0019

Driver TMA Dritti



TMA Driver Esagonale
per Cricchetto 20mm

RS6197



TMA Adattatore Esagonale
per Contrangolo 20mm

RS6194



TMA Adattatore Esagonale
per Contrangolo 25mm

RS6195A

Presca d'impronta Narrow

Torque raccomandato 15(Ncm)

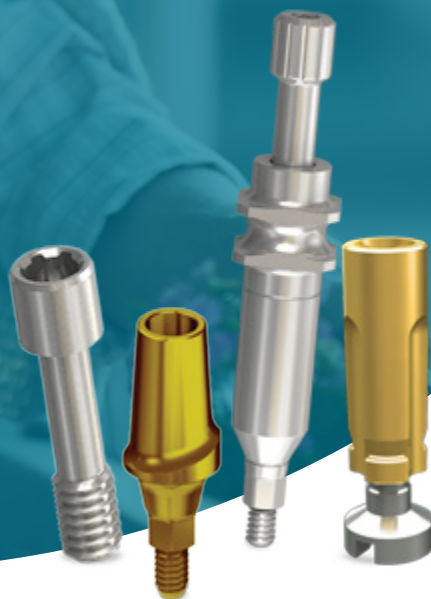



I componenti per la presa d'impronta sono compatibili con tutti i tipi di restauri e sono adatti per le procedure analogiche e digitali, sia a livello implantare che a livello dell'abutment.

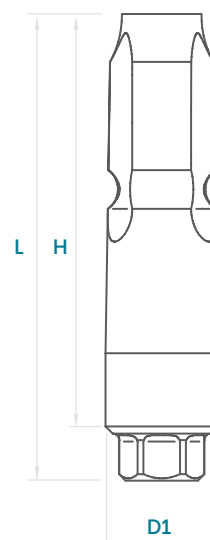

L'ampia gamma di soluzioni protesiche consente una pianificazione semplice ma al tempo stesso accurata, dal dente singolo al full-arch.



NP Transfer & Analoghi (A livello dell'impianto)

NP™ Transfer		L	∅	D1	H	Codice Art.
	NP Transfer a Cucchiaino Chiuso Slim	15.2	3.2	2.5	13.0	NP5113
	NP Transfer a Cucchiaino Chiuso	15.2	4.3	2.5	13.0	NP5213
	NP Transfer a Cucchiaino Aperto Slim	18.0	5.0	2.5	14.0	NP5614
	NP Transfer a Cucchiaino Aperto	18.0	6.0	2.5	14.0	NP5514

NP™ Analogo		L	∅	D1	Codice Art.
	NP Analogo Impianto	12.6	3.0	2.5	NP0007

NP™ Viti Transfer		L	∅	Codice Art.
	NP Vite per Transfer a Cucchiaino Aperto	28.0	3.1	NP5014
	NP Vite per Transfer a Cucchiaino Chiuso	20.0	2.8	NP5127
	NP Vite Recupero per Abutment	13.4	2.0	NP0014

UNP Transfer & Analoghi (A livello dell'impianto)

UNP™ Transfer		L	∅	D1	H	Codice Art.
	UNP Transfer a Cucchiaino Aperto Slim	18.30	5.00	2.27	14.00	UNP5614
	UNP Transfer a Cucchiaino Aperto	18.30	6.00	2.27	14.00	UNP5514
	UNP Transfer a Cucchiaino Chiuso Slim	15.30	3.20	2.27	13.00	UNP5113
	UNP Transfer a Cucchiaino Chiuso	15.30	4.00	2.27	13.00	UNP5213









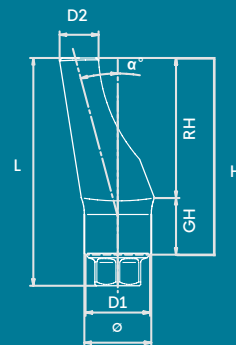

UNP™ Analogo		L	∅	D1	Codice Art.
	UNP Analogo Impianto	12.60	2.75	2.27	UNP0007

UNP™ Viti Transfer		L	∅	Codice Art.
	UNP Vite per Transfer a Cucchiaino Chiuso	20.00	2.80	UNP5127
	UNP Vite per Transfer a Cucchiaino Aperto	28.00	3.10	UNP5014

NP™ Protesi cementata

Torque raccomandato 25 (Ncm)



Abutment	L	ø	D1	D2	H	GH	RH	Codice Art.
 NP Straight Slim Abutment Senza Spalla	11.0	3.5	2.5	3.0	8.8	3.2	5.7	NP0010
 NP Abutment Dritto	9.7	4.4	2.5	3.0	7.5	1.0	6.5	NP0019
	10.7	4.4	2.5	3.0	8.5	2.0	6.5	NP0011
	11.7	4.4	2.5	3.0	9.5	3.0	6.5	NP0064
 NP Abutment Angolato 15° Senza Spalla	11.7	4.3	2.5	1.9	9.5	1.4	8.2	NP0018
 NP Abutment Angolato 15°	9.7	4.8	2.5	2.4	7.5	1.0	6.5	NP0015
	10.7	4.8	2.5	2.4	8.5	2.0	6.5	NP0026
	11.7	4.8	2.5	2.4	9.5	3.0	6.5	NP0063
 NP Abutment Angolato 25° Senza Spalla	10.0	3.8	2.5	1.9	7.8	1.6	6.5	NP0025
 NP Abutment Provvisorio Anti-Rotazionale	11.0	3.7	2.5	3.2	8.8	0.7	8.0	NP0043
 NP Abutment Provvisorio Rotazionale	11.0	3.7	2.5	3.2	8.8	0.7	8.0	NP0044
 NP Abutment Titanio/Plastica Anti-Rotazionale	13.2	4.2	2.5	4.2	11.0	1.0	10.0	NP3095
 NP Abutment Titanio/Plastica Rotazionale	13.2	4.2	2.5	4.2	11.0	1.0	10.0	NP3097
 NP Abutment Cromo Cobalto/Plastica Rotazionale	13.2	4.2	2.5	4.2	11.0	1.0	10.0	NP3094
 NP Abutment Cromo Cobalto/Plastica Rotazionale	13.2	4.2	2.5	4.2	11.0	1.0	10.0	NP3100

Vite NP0001 inclusa nella confezione

UNP™ Protesi cementata

Torque raccomandato 25 (Ncm)

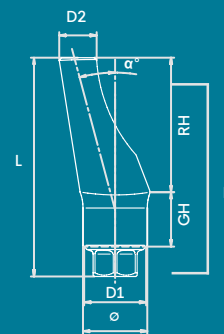

UNP™ Abutment	L	Ø	D1	D2	H	GH	RH	Codice Art.
 UNP Straight Slim Abutment Senza Spalla	11.00	3.50	2.27	2.89	8.70	1.00	7.30	UNP0010
 UNP Abutment Dritto	9.85	4.20	2.27	3.00	7.55	1.00	6.50	UNP0019
	10.85	4.20	2.27	3.00	8.55	2.00	6.50	UNP0011
	11.85	4.20	2.27	3.00	9.55	3.00	6.50	UNP0064
 UNP Abutment Angolato 15° Senza Spalla	10.00	3.50	2.27	1.60	7.70	1.00	6.10	UNP0018
 UNP Abutment Angolato 15°	9.85	4.20	2.27	2.40	7.55	1.00	6.50	UNP0063
	10.85	4.20	2.27	2.40	8.55	2.00	6.50	UNP0015
	11.85	4.20	2.27	2.40	9.55	3.00	6.50	UNP0026
 UNP Abutment Provvisorio Anti-Rotazionale	12.30	3.70	2.27	3.20	10.00	2.00	8.00	UNP0043
 UNP Abutment Provvisorio Rotazionale	12.30	3.70	2.27	3.20	10.00	2.00	8.00	UNP0044
 UNP Abutment Cilindrico Calcinabile Anti-rotazionale	12.30	3.70	2.27	3.00	10.00	2.00	8.00	UNP0045
 UNP Abutment Cromo Cobalto/Plastica Anti-Rotazionale	12.30	3.70	2.27	3.20	10.00	2.00	8.00	UNP3094
 UNP Abutment Cromo Cobalto/Plastica Rotazionale	12.30	3.70	2.27	3.00	10.00	2.00	8.00	UNP3100

Vite UNP0001 inclusa nella confezione



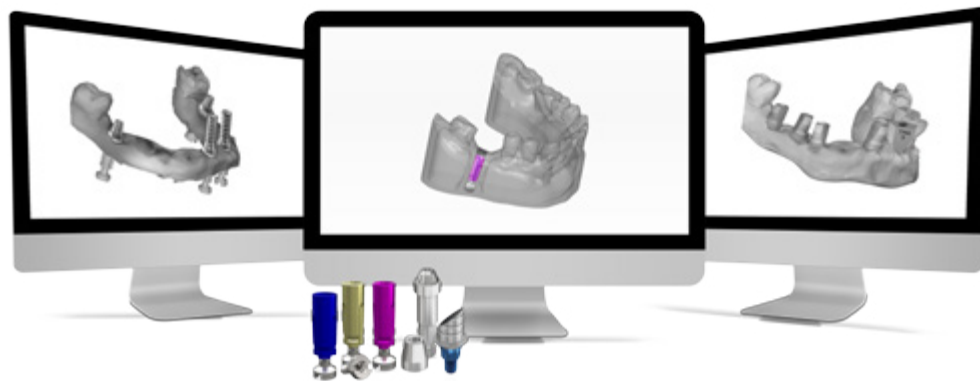

CAD CAM





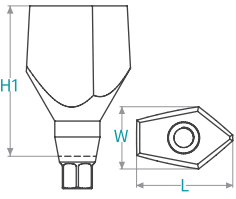



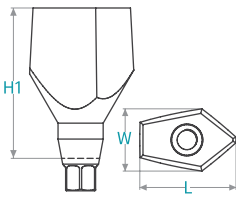

I componenti CAD - CAM e le librerie digitali consentono al Clinico e al Tecnico di creare manufatti protesici di alto livello su impianti Adin, secondo i più attuali protocolli di workflow digitale.

L'ampia gamma di componenti disponibili risponde a qualsiasi esigenza protesica, dal dente singolo a casi di edentulia parziale o totale.

Scan Body NP & UNP per impianto

NP Scan Body	Per Scanner Intra-orale e da laboratorio	
	NP CloseFit™ Scan Body 7mm	NP CloseFit™ Scan Body 10mm
		
Codice Art.	NP0088	NP0089
Vite di Ritenzione inclusa	NP0001	NP0001
		
Misure	H1: 7 mm W: 4.2 mm L: 6.7 mm	H1: 10 mm W: 4.5 mm L: 6.9 mm

UNP Scan Body	Per Scanner Intra-orale e da laboratorio	
	UNP CloseFit™ Scan Body 7mm	UNP CloseFit™ Scan Body 10mm
		
Codice Art.	UNP0088	UNP0089
Vite di Ritenzione inclusa	UNP0001	UNP0001
		
Misure	H1: 7 mm W: 4.2 mm L: 6.7 mm	H1: 10 mm W: 4.5 mm L: 6.9 mm

Analogo Digitale	NP CloseFit™ Analogo Digitale	UNP CloseFit™ Analogo Digitale	Vite di Ritenzione
			
Codice Art.	NP1000	UNP1000	RS1002

Avvitare con Driver da 1.27 mm

Ti Base

Anti-Rotazionale

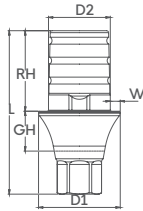
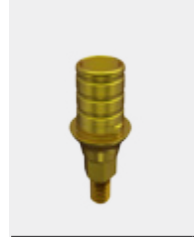

		RH	GH	D1	D2	L	W
TB02411	Ti Base NP Abutment, RH 4mm GH 1.5mm Anti-Rotazionale	4	1.5	4.1	3.1	7.7	0.5
TB02421	Ti Base NP Abutment, RH 4mm GH 2mm Anti-Rotazionale	4	2	4.1	3.1	8.2	0.5
TB02431	Ti Base NP Abutment, RH 4mm GH 3mm Anti-Rotazionale	4	3	4.1	3.1	9.2	0.5
TB02441	Ti Base NP Abutment, RH 4mm GH 4mm Anti-Rotazionale	4	4	4.1	3.1	10.2	0.5
TB02611	Ti Base NP Abutment, RH 6mm GH 1.5mm Anti-Rotazionale	6	1.5	4.1	3.1	9.7	0.5
TB02621	Ti Base NP Abutment, RH 6mm GH 2mm Anti-Rotazionale	6	2	4.1	3.1	10.2	0.5
TB02631	Ti Base NP Abutment, RH 6mm GH 3mm Anti-Rotazionale	6	3	4.1	3.1	11.2	0.5
TB02641	Ti Base NP Abutment, RH 6mm GH 4mm Anti-Rotazionale	6	4	4.1	3.1	12.2	0.5
TB02811	Ti Base NP Abutment, RH 8mm GH 1.5mm Anti-Rotazionale	8	1.5	4.1	3.1	11.7	0.5
TB02821	Ti Base NP Abutment, RH 8mm GH 2mm Anti-Rotazionale	8	2	4.1	3.1	12.2	0.5

Rotazionale

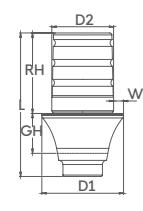

		RH	GH	D1	D2	L	W
TB02412	Ti Base NP Abutment, RH 4mm GH 1.5mm Rotazionale	4	1.5	4.1	3.1	6.7	0.5
TB02422	Ti Base NP Abutment, RH 4mm GH 2mm Rotazionale	4	2	4.1	3.1	7.2	0.5
TB02432	Ti Base NP Abutment, RH 4mm GH 3mm Rotazionale	4	3	4.1	3.1	8.2	0.5
TB02442	Ti Base NP Abutment, RH 4mm GH 4mm Rotazionale	4	4	4.1	3.1	9.2	0.5
TB02612	Ti Base NP Abutment, RH 6mm GH 1.5mm Rotazionale	6	1.5	4.1	3.1	8.7	0.5
TB02622	Ti Base NP Abutment, RH 6mm GH 2mm Rotazionale	6	2	4.1	3.1	9.2	0.5
TB02632	Ti Base NP Abutment, RH 6mm GH 3mm Rotazionale	6	3	4.1	3.1	10.2	0.5
TB02642	Ti Base NP Abutment, RH 6mm GH 4mm Rotazionale	6	4	4.1	3.1	11.2	0.5
TB02812	Ti Base NP Abutment, RH 8mm GH 1.5mm Rotazionale	8	1.5	4.1	3.1	10.7	0.5
TB02822	Ti Base NP Abutment, RH 8mm GH 2mm Rotazionale	8	2	4.1	3.1	11.2	0.5

Anti-Rotazionale
Angolato

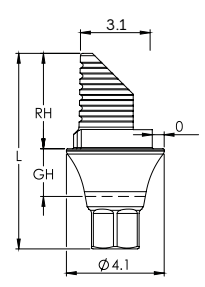

		RH	GH	D1	D2	L	W
TB02413	Ti Base NP Abutment, RH 4mm GH 1.5mm Anti-Rotazionale Angolato	4	1.5	4.1	3.1	7.7	0.5
TB02423	Ti Base NP Abutment, RH 4mm GH 2mm Anti-Rotazionale Angolato	4	2	4.1	3.1	8.2	0.5
TB02433	Ti Base NP Abutment, RH 4mm GH 3mm Anti-Rotazionale Angolato	4	3	4.1	3.1	9.2	0.5
TB02613	Ti Base NP Abutment, RH 6mm GH 1.5mm Anti-Rotazionale Angolato	6	1.5	4.1	3.1	9.7	0.5
TB02623	Ti Base NP Abutment, RH 6mm GH 2mm Anti-Rotazionale Angolato	6	2	4.1	3.1	10.2	0.5
TB02633	Ti Base NP Abutment, RH 6mm GH 3mm Anti-Rotazionale Angolato	6	3	4.1	3.1	11.2	0.5
TB02813	Ti Base NP Abutment, RH 6mm GH 1.5mm Anti-Rotazionale Angolato	8	1.5	4.1	3.1	11.7	0.5
TB02823	Ti Base NP Abutment, RH 8mm GH 2mm Anti-Rotazionale Angolato	8	2	4.1	3.1	12.2	0.5

Driver ASC			D1	D2	L	L2
	RP6401	Driver manuale per vite foro angolato Star - Short 23.4 L	9.4	1.4	23.4	9.0
	RP6402	Driver manuale per vite foro angolato Star - Long 28.4 L	9.4	1.4	28.4	14.0
	RP6403	Driver da cricchetto per vite foro angolato Star - Short 17.0 L	7.0	1.4	17.0	11.0
	RP6404	Driver da cricchetto per vite foro angolato Star - Long 22.0 L	7.0	1.4	22.0	16.0
	RP6405	Driver da contrangolo per vite foro angolato Star - Extra Short 20.0 L	2.35	1.4	20.0	7.0
	RP6406	Driver da contrangolo per vite foro angolato Star - Short 25.0 L	2.35	1.4	25.0	12.0
	RP6407	Driver da contrangolo per vite foro angolato Star - Long 30.0 L	2.35	1.4	30.0	17.0

Anti-Rotazionale

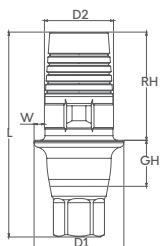

		RH	GH	D1	D2	L	W	Post
TB02414	C-Type Ti Base NP Abutment, GH 1.5mm Anti-Rotazionale	4.7	1.5	3.9	3	8.36	0.45	Small
TB02424	C-Type Ti Base NP Abutment, GH 2mm Anti-Rotazionale	4.7	2	3.9	3	8.86	0.45	Small
TB02434	C-Type Ti Base NP Abutment, GH 3mm Anti-Rotazionale	4.7	3	3.9	3	9.86	0.45	Small
TB02444	C-Type Ti Base NP Abutment, GH 4mm Anti-Rotazionale	4.7	4	3.9	3	10.86	0.45	Small

Rotazionale

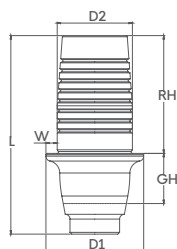

		RH	GH	D1	D2	L	W	Post
TB02415	C-Type Ti Base NP Abutment, GH 1.5mm Rotazionale	4.7	1.5	4.1	3.1	6.8	0.5	Small
TB02425	C-Type Ti Base NP Abutment, GH 2mm Rotazionale	4.7	2	4.1	3.1	7.3	0.5	Small
TB02435	C-Type Ti Base NP Abutment, GH 3mm Rotazionale	4.7	3	4.1	3.1	8.3	0.5	Small
TB02445	C-Type Ti Base NP Abutment, GH 4mm Rotazionale	4.7	4	4.1	3.1	9.3	0.5	Small

Ti Blank

| Per Medentika PreFace® Holders

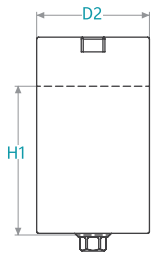

NP CloseFit™
Ti Pre Milled MDTK
Abutment Blank
ø11.5mm

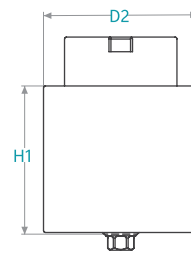

NP CloseFit™
Ti Pre Milled MDTK
Abutment Blank
ø15.8mm



Codice Art.	NP1111	Codice Art.	NP1115
Vite di Ritenzione inclusa	NP0001	Vite di Ritenzione inclusa	NP0001
Misure	H1: 15.4 mm D2: ø11.5 mm	Misure	H1: 15.4 mm D2: ø15.8 mm
Utilizzo	Abutment customizzato per elemento singolo	Utilizzo	Abutment customizzato per elemento singolo

Vite Abutment Narrow

NP CloseFit™
Vite Abutment



Codice Art.	NP0001
Utilizzo	Per NP Scan Body, Ti Base, TiBase angolati and Blank

UNP™ Ti Base

Ti Base

Anti-Rotazionale

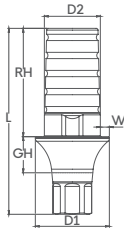

		RH	GH	D1	D2	L	W
TB06411	Ti Base UNP Abutment, RH 4mm GH 1.5mm Anti-Rotazionale	4	1.5	4.1	3.1	7.8	0.5
TB06421	Ti Base UNP Abutment, RH 4mm GH 2mm Anti-Rotazionale	4	2	4.1	3.1	8.3	0.5
TB06431	Ti Base UNP Abutment, RH 4mm GH 3mm Anti-Rotazionale	4	3	4.1	3.1	9.3	0.5
TB06441	Ti Base UNP Abutment, RH 4mm GH 4mm Anti-Rotazionale	4	4	4.1	3.1	10.3	0.5
TB06611	Ti Base UNP Abutment, RH 6mm GH 1.5mm Anti-Rotazionale	6	1.5	4.1	3.1	9.8	0.5
TB06621	Ti Base UNP Abutment, RH 6mm GH 2mm Anti-Rotazionale	6	2	4.1	3.1	10.3	0.5
TB06631	Ti Base UNP Abutment, RH 6mm GH 3mm Anti-Rotazionale	6	3	4.1	3.1	11.3	0.5
TB06641	Ti Base UNP Abutment, RH 6mm GH 4mm Anti-Rotazionale	6	4	4.1	3.1	12.3	0.5
TB06811	Ti Base UNP Abutment, RH 8mm GH 1.5mm Anti-Rotazionale	8	1.5	4.1	3.1	11.8	0.5
TB06821	Ti Base UNP Abutment, RH 8mm GH 2mm Anti-Rotazionale	8	2	4.1	3.1	12.3	0.5

Rotazionale

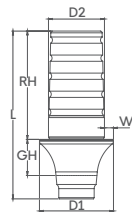

		RH	GH	D1	D2	L	W
TB06412	Ti Base UNP Abutment, RH 4mm GH 1.5mm Rotazionale	4	1.5	4.1	3.1	6.8	0.5
TB06422	Ti Base UNP Abutment, RH 4mm GH 2mm Rotazionale	4	2	4.1	3.1	7.3	0.5
TB06432	Ti Base UNP Abutment, RH 4mm GH 3mm Rotazionale	4	3	4.1	3.1	8.3	0.5
TB06442	Ti Base UNP Abutment, RH 4mm GH 4mm Rotazionale	4	4	4.1	3.1	9.3	0.5
TB06612	Ti Base UNP Abutment, RH 6mm GH 1.5mm Rotazionale	6	1.5	4.1	3.1	8.8	0.5
TB06622	Ti Base UNP Abutment, RH 6mm GH 2mm Rotazionale	6	2	4.1	3.1	9.3	0.5
TB06632	Ti Base UNP Abutment, RH 6mm GH 3mm Rotazionale	6	3	4.1	3.1	10.3	0.5
TB06642	Ti Base UNP Abutment, RH 6mm GH 4mm Rotazionale	6	4	4.1	3.1	11.3	0.5
TB06812	Ti Base UNP Abutment, RH 8mm GH 1.5mm Rotazionale	8	1.5	4.1	3.1	10.8	0.5
TB06822	Ti Base UNP Abutment, RH 8mm GH 2mm Rotazionale	8	2	4.1	3.1	11.3	0.5

Anti-Rotazionale Angolato

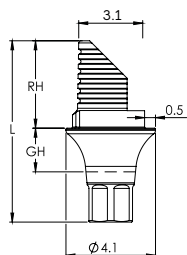

		RH	GH	D1	D2	L	W
TB06413	Ti Base UNP Abutment, RH 4mm GH 1.5mm Anti-Rotazionale Angolato	4	1.5	4.1	3.1	7.8	0.5
TB06423	Ti Base UNP Abutment, RH 4mm GH 2mm Anti-Rotazionale Angolato	4	2	4.1	3.1	8.3	0.5
TB06433	Ti Base UNP Abutment, RH 4mm GH 3mm Anti-Rotazionale Angolato	4	3	4.1	3.1	9.3	0.5
TB06613	Ti Base UNP Abutment, RH 6mm GH 1.5mm Anti-Rotazionale Angolato	6	1.5	4.1	3.1	9.8	0.5
TB06623	Ti Base UNP Abutment, RH 6mm GH 2mm Anti-Rotazionale Angolato	6	2	4.1	3.1	10.3	0.5
TB06633	Ti Base UNP Abutment, RH 6mm GH 3mm Anti-Rotazionale Angolato	6	3	4.1	3.1	11.3	0.5
TB06813	Ti Base UNP Abutment, RH 8mm GH 1.5mm Anti-Rotazionale Angolato	8	1.5	4.1	3.1	11.8	0.5
TB06823	Ti Base UNP Abutment, RH 8mm GH 2mm Anti-Rotazionale Angolato	8	2	4.1	3.1	12.3	0.5

Driver ASC

			D1	D2	L	L2
	RP6401	Driver manuale per vite foro angolato Star - Short 23.4 L	9.4	1.4	23.4	9.0
	RP6402	Driver manuale per vite foro angolato Star - Long 28.4 L	9.4	1.4	28.4	14.0
	RP6403	Driver da cricchetto per vite foro angolato Star - Short 17.0 L	7.0	1.4	17.0	11.0
	RP6404	Driver da cricchetto per vite foro angolato Star - Long 22.0 L	7.0	1.4	22.0	16.0
	RP6405	Driver da contrangolo per vite foro angolato Star - Extra Short 20.0 L	2.35	1.4	20.0	7.0
	RP6406	Driver da contrangolo per vite foro angolato Star - Short 25.0 L	2.35	1.4	25.0	12.0
	RP6407	Driver da contrangolo per vite foro angolato Star - Long 30.0 L	2.35	1.4	30.0	17.0

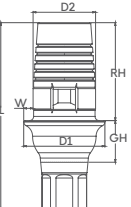
Anti-Rotazionale			RH	GH	D1	D2	L	W	Post
									
TB06414	C-Type Ti Base UNP Abutment, GH 1.5mm Anti-Rotazionale	4.7	1.5	3.9	3	8.5	0.45	Small	
TB06424	C-Type Ti Base UNP Abutment, GH 2mm Anti-Rotazionale	4.7	2	3.9	3	9	0.45	Small	
TB06434	C-Type Ti Base UNP Abutment, GH 3mm Anti-Rotazionale	4.7	3	3.9	3	10	0.45	Small	
TB06444	C-Type Ti Base UNP Abutment, GH 4mm Anti-Rotazionale	4.7	4	3.9	3	11	0.45	Small	

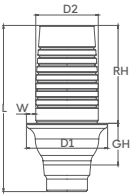
Rotazionale			RH	GH	D1	D2	L	W	Post
									
TB06415	C-Type Ti Base UNP Abutment, GH 1.5mm Rotazionale	4.7	1.5	3.9	3	8.5	0.45	Small	
TB06425	C-Type Ti Base UNP Abutment, GH 2mm Rotazionale	4.7	2	3.9	3	9	0.45	Small	
TB06435	C-Type Ti Base UNP Abutment, GH 3mm Rotazionale	4.7	3	3.9	3	10	0.45	Small	
TB06445	C-Type Ti Base UNP Abutment, GH 4mm Rotazionale	4.7	4	3.9	3	11	0.45	Small	

Ti Blank

| Per Medentika PreFace® Holders

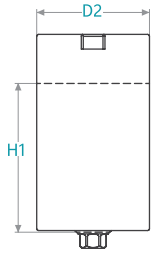

UNP CloseFit™
Ti Pre Milled MDTK
Abutment Blank
Ø11.5mm

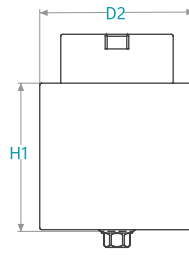

UNP CloseFit™
Ti Pre Milled MDTK
Abutment Blank
Ø15.8mm



Codice Art.	UNP1711	Codice Art.	UNP1715
Vite di Ritenzione inclusa	UNP0001	Vite di Ritenzione inclusa	UNP0001
Misure	H1: 15.4 mm D2: Ø11.5 mm	Misure	H1: 15.4 mm D2: Ø15.8 mm
Utilizzo	Abutment customizzato per elemento singolo	Utilizzo	Abutment customizzato per elemento singolo

Vite Abutment Ultra Narrow

UNP CloseFit™
Vite Abutment



Codice Art.	UNP0001
Utilizzo	Per UNP Scan Body, Ti Base, TiBase angolati e Blank

NP TMA™ - Multi Unit

Torque raccomandato 35(Ncm)

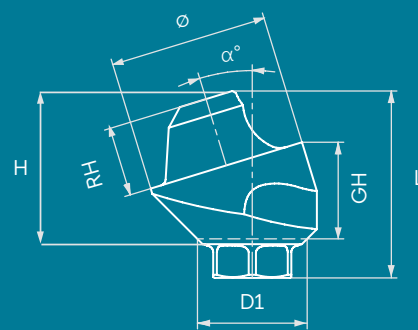

Il sistema di abutment transmucosi TMA™ è indicato per protesi avvitata multipla e può essere utilizzato in combinazione con una realizzazione protesica tradizionale.

Serve per elevare la piattaforma di appoggio della protesi laddove il restauro a livello dell'impianto non sia indicato oppure non sia realizzabile a causa della profondità o angolazione dell'impianto stesso.



Il sistema TMA™ nasce inoltre per consentire un migliore accesso protesico su impianti inclinati in arcate totalmente o parzialmente edentule ed in particolare nel caso di impianti inclinati con protesi full-arch "all-on-x".

Il Sistema TMA™ include abutment dritti e angolati (17°,30°), con ingaggio ad esagono interno in diverse altezze e indice esagonale. Ogni abutment viene fornito completo di portatore che ne agevola il prelevamento e posizionamento.

TMA dritti	L	Ø	D1	D2	H	GH	RH	Codice Art.
 NP Abutment Transmucoso Dritto 1mm	4.2	4.9	2.5	-	2.0	1.0	2.10	NP0032
NP Abutment Transmucoso Dritto 2mm	5.2	4.9	2.5	-	3.0	2.0	2.10	NP0033
NP Abutment Transmucoso Dritto 3mm	6.2	4.9	2.5	-	4.0	3.0	2.10	NP0034
NP Abutment Transmucoso Dritto 4mm	7.2	4.9	2.5	-	5.0	4.0	2.10	NP3729
NP Abutment Transmucoso Dritto 5mm	8.2	4.9	2.5	-	6.0	5.0	2.10	NP3730

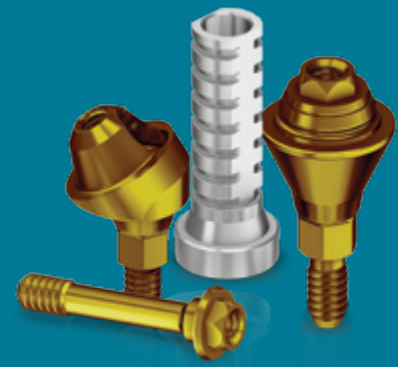
Viti incluse nella confezione	L	Ø	Codice Art.
 NP Vite di Ritenzione per TMA 1mm	8.0	3.1	NP0039
 NP Vite di Ritenzione per TMA 2mm	9.0	3.1	NP0040
 NP Vite di Ritenzione per TMA 3mm	10.0	3.1	NP0041
 NP Vite di Ritenzione per TMA 4mm	11.0	3.1	NP3409
 NP Vite di Ritenzione per TMA 5mm	12.0	3.1	NP3412





TMA angolati		L	∅	D1	D2	H	GH	RH	Codice Art.
	NP Abutment Transmucoso Angolato 17°	6.8	4.9	2.5	-	-	2.8	2.15	NP0035
	NP Abutment Transmucoso Angolato 17°	7.9	4.9	2.5	-	-	3.9	2.15	NP0038
	NP Abutment Transmucoso Angolato 30°	6.9	4.9	2.5	-	-	3.5	2.15	NP0036
	NP Abutment Transmucoso Angolato 30°	8.1	4.9	2.5	-	-	4.9	2.15	NP0037

Vite NP0042 inclusa nella confezione

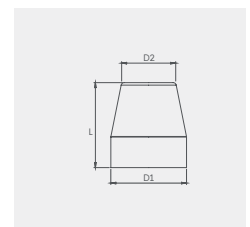
TMA Cappetta di Guarigione		L	D1	D2	Codice Art.
	TMA Cappetta di Guarigione	5.5	4.9	3.5	RS5005
	TMA Cappetta di Guarigione	7.0	4.9	3.5	RS5003





Vite RS3404 inclusa nella confezione

NP™ Viti		L	∅	Codice Art.
	Vite per TMA Angolato	7.1	2	NP0042
	TMA Vite Protetica 15(Ncm)	4.1	2.1	RS3404

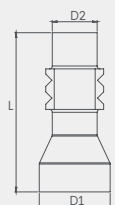
NP Protesi per TMA™



TMA Transfer		L	D1	D2	Codice Art.
	TMA Transfer per Impronta a Cucchiaino Aperto (Vite RS5008 inclusa nella confezione)	11.0	4.9	3.1	RS5006
	TMA Transfer per Impronta a Cucchiaino Chiuso (Vite RS5009 inclusa nella confezione)	8.0	4.9	4.1	RS5011

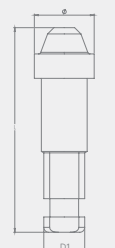

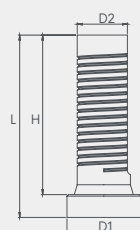

TMA Analogo		L	D1	Codice Art.
	TMA Analogo	16.8	4.9	RS5004



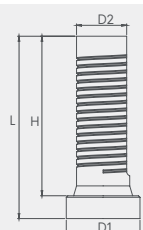

TMA Abutment Calcinabile		L	D1	D2	H	Codice Art.
	TMA Abutment Calcinabile (Vite RS3404 inclusa nella confezione)	12.0	4.9	3.3	10.5	RS5001





TMA Abutment Provvisorio		L	D1	D2	H	Codice Art.
	TMA Abutment Provvisorio in Titanio (Vite RS3404 inclusa nella confezione)	12.0	4.9	3.5	10.5	RS4900

TMA Viti		L	∅	Codice Art.
	TMA Vite per Transfer a Cucchiaino Aperto	14	2.1	RS5008
	TMA Vite per Transfer a Cucchiaino Chiuso	6.8	2.5	RS5009

NP Protesi Digitale per TMA™

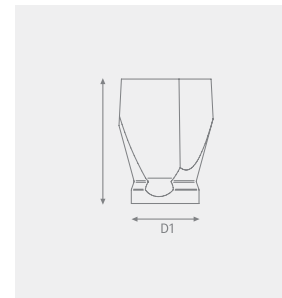
TMA Scan Body		L	D1	Codice Art.
	TMA Scan Body (Vite TM0001 inclusa nella confezione)	6.0	4.9	TM0006
		9.0	4.9	TM0009



TMA Analogo Modello Digitale		L	D1	D2	Codice Art.
	TMA Analogo Modello Digitale	12.0	4.9	3.35	RS1001

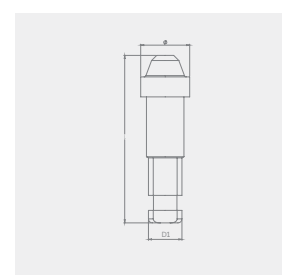

Utilizzare con driver protesico esagonale da 1.27.

TMA Abutment da incollaggio		L	D1	D2	H	W	Codice Art.
	TMA Abutment da incollaggio	4.9	4.9	3.9	3.4	0.5	TM0010
	TMA Abutment da incollaggio, low profile	4.9	5.5	4.5	4.4	0.5	TM0011

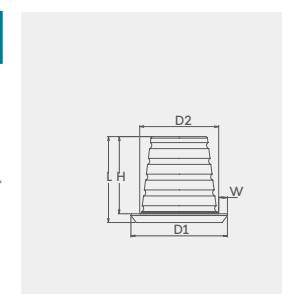

Vite TM0001 inclusa nella confezione

TMA Abutment Provvisorio		L	D1	D2	H	Codice Art.
	TMA Abutment Provvisorio in Titanio (Vite RS3404 inclusa nella confezione)	12.0	4.9	3.5	10.5	RS4900

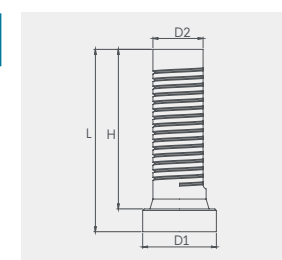

TMA Viti		Codice Art.
	TMA Vite Scan Body	TM0001

NP Narrow Single TMA™

Torque raccomandato 35(Ncm)

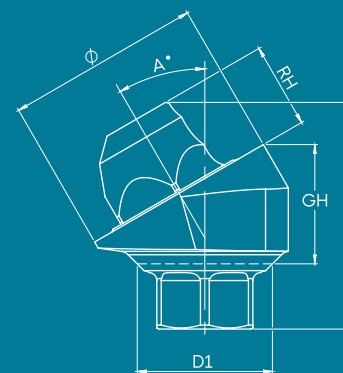

Il sistema STMA (Single Trans Mucosal Abutment) utilizza tutti i vantaggi della linea TMA MultiUnit, consentendo al contempo la precisione e la flessibilità della protesi avvitata su singolo elemento. Il sistema contempla la possibilità di restauri protesici full digital, offrendo una linea di soluzioni esclusive, moderne e complete tale da garantire al professionista la scelta più adeguata per l'ottenimento del miglior risultato estetico.

NP STMA Abutment		L	D1	Ø	GH	RH	Codice Art.
	NP Abutment Dritto Single TMA 1mm	4.2	2.5	4.9	1.0	2.1	NP0032S
	NP Abutment Dritto Single TMA 2mm	5.2	2.5	4.9	2.0	2.1	NP0033S
	NP Abutment Dritto Single TMA 3mm	6.2	2.5	4.9	3.0	2.1	NP0034S
	NP Abutment Dritto Single TMA 4mm	7.2	2.5	4.9	4.0	2.1	NP3729S
	NP Abutment Dritto Single TMA 5mm	8.2	2.5	4.9	5.0	2.1	NP3730S

Viti incluse nella confezione		L	Ø	Codice Art.
	NP Vite di Ritenzione per TMA 1mm	8.0	3.1	NP0039
	NP Vite di Ritenzione per TMA 2mm	9.0	3.1	NP0040
	NP Vite di Ritenzione per TMA 3mm	10.0	3.1	NP0041
	NP Vite di Ritenzione per TMA 4mm	11.0	3.1	NP3409
	NP Vite di Ritenzione per TMA 5mm	12.0	3.1	NP3412





NP STMA Abutment		L	D1	Ø	GH	RH	Codice Art.
	NP Abutment Angolato Single TMA 17° 3mm	6.6	2.5	4.9	2.8	2.15	NP0035S
	NP Abutment Angolato Single TMA 30° 3.5mm	6.7	2.5	4.9	3.5	2.15	NP0036S
	NP Abutment Angolato Single TMA 30° 5mm	8.1	2.5	4.9	4.9	2.15	NP0037S
	NP Abutment Angolato Single TMA 17° 4mm	7.7	2.5	4.9	3.9	2.15	NP0038S

Vite NP0042 inclusa nella confezione

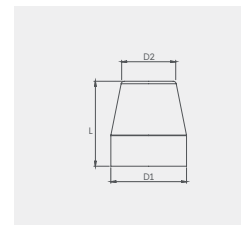
NP STMA Cappetta di Guarigione		L	D1	D2	Codice Art.
	TMA Cappetta di Guarigione	5.5	4.9	3.5	RS5005S





Vite RS3404 inclusa nella confezione

NP™ Viti	L	Ø	Codice Art.	
	Vite per TMA Angolato	7.1	2	NP0042
	TMA Vite Protetica 15(Ncm)	4.1	2.1	RS3404

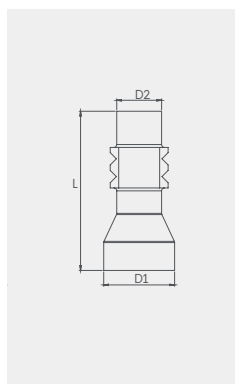
NP Protesi per Single TMA™



STMA Transfer		L	D1	D2	Codice Art.
	Single TMA Transfer per impronta a Cucchiaino Aperto (Vite RS5008 inclusa nella confezione)	11.0	4.9	3.1	RS5006S
	Single TMA Transfer per impronta a Cucchiaino Chiuso (Vite RS5009 inclusa nella confezione)	8.0	4.9	4.1	RS5011S

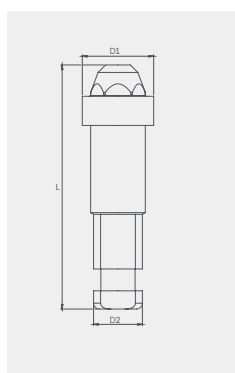

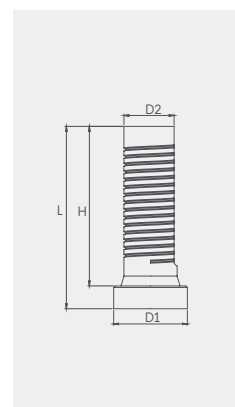

STMA Analogo		L	D1	Codice Art.
	Single TMA Analogo	16.75	4.9	RS5004S



STMA Abutment		L	D1	D2	H	Codice Art.
	Single TMA Abutment Provvisorio in Titanio (Vite RS3404 inclusa nella confezione)	12.0	4.9	3.5	10.5	RS4900S
	Single TMA Abutment Calcinabile con Vite Protetica (Vite RS3404 inclusa nella confezione)	12.0	4.9	3.5	10.35	RS5001S

NP Protesi Digitale per Single TMA™

STMA Scan Body	L	D1	Codice Art.		
	6.0	4.9	TM0006S		
	9.0	4.9	TM0009S		
Single TMA Scan Body (Vite TM0001 inclusa nella confezione)					

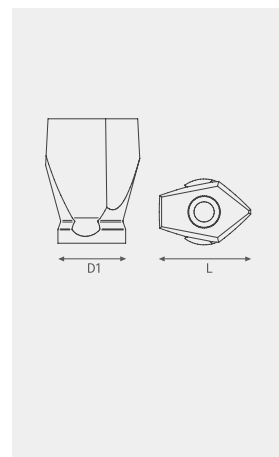

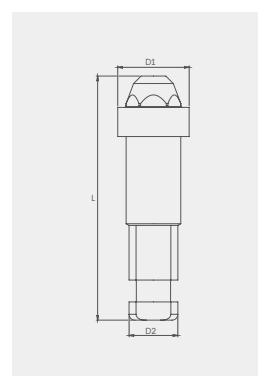

STMA Analogo Modello Digitale	L	D1	D2	Codice Art.	
	12.0	4.9	3.8	RS1001S	

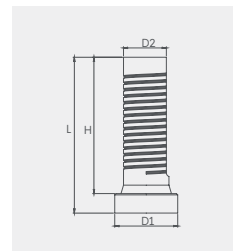

Utilizzare con driver protesico esagonale da 1.27.

STMA Abutment Provvisorio	L	D1	D2	H	Codice Art.	
	12.0	4.9	3.5	10.5	RS4900S	



STMA Abutment da incollaggio	L	D1	D2	H	W	Codice Art.	
	4.9	5.5	4.5	4.4	0.5	TM0011S	

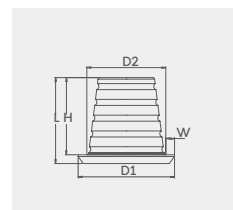

Protesi Overdenture Narrow

Torque raccomandato 25(Ncm)

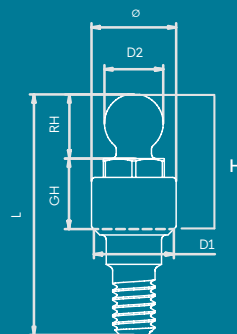

UNP™ (Avvitare con Driver da 1.27 mm)		L	Ø	D1	D2	H	GH	RH	Codice Art.
	UNP™ Attacco a sfera	7.75	2.40	2.27	2.50	3.00	0.50	2.45	UNP0020
		8.25	2.40	2.27	2.50	3.50	1.00	2.45	UNP0021
		9.25	2.40	2.27	2.50	4.50	2.00	2.45	UNP0022
		10.25	2.40	2.27	2.50	5.50	3.00	2.45	UNP0023
		11.25	2.40	2.27	2.50	6.50	4.00	2.45	UNP0024
		12.25	2.40	2.27	2.50	7.50	5.00	2.45	UNP0025

NP™ (Avvitare con Driver RS6090)		L	Ø	D1	D2	H	GH	RH	Codice Art.
	NP™ Attacco a sfera	8.8	2.9	2.5	2.5	4.1	0.5	3.5	NP0020
		9.2	2.9	2.5	2.5	4.5	1.0	3.5	NP0021
		10.2	2.9	2.5	2.5	5.5	2.0	3.5	NP0022
		11.2	2.9	2.5	2.5	6.5	3.0	3.5	NP0023
		12.2	2.9	2.5	2.5	7.5	4.0	3.5	NP0024

Cappette per Attacco a sfera		L	Ø	D2	Codice Art.
	Cappetta Bianca per Attacco a sfera (Nylon)	2.60	4.10	3.60	RS2660
	Cappetta Rosa Soft per Attacco a sfera (Nylon)	2.60	4.10	3.60	RS2662
	Cappetta in Titanio per Attacco a sfera	2.90	4.70	4.70	RS2670

Analogo		L	Ø	D1	GH	RH	Codice Art.
	Analogo Attacco a sfera	16.60	4.00	2.5	0.80	2.7	RS5740

Utilizzare con driver protesico esagonale da 1.27.

Grip™

Attacchi per overdenture

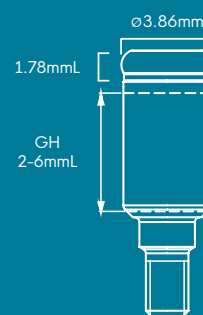
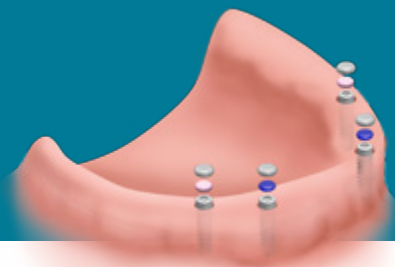

Le protesi overdenture su impianti sono tra le scelte più pratiche per i pazienti che non possono utilizzare restauri fissi. Inoltre, possono rappresentare anche una soluzione provvisoria per i pazienti che attendono il processo di osteointegrazione degli impianti appena inseriti.

Il sistema di attacchi Grip™ rappresenta una risposta versatile, progettata per garantire la massima stabilità della protesi, sia in arcata superiore che inferiore. La vasta gamma di cappette ritentive consente al professionista di individuare la soluzione migliore per ogni singolo caso.

Il sistema di attacchi Grip™ è disponibile in un'ampia gamma di altezze gengivali, in modo da garantire una soluzione sicura e affidabile a lungo termine.

Grip™ componenti



NP CloseFit™ Grip™ abutment

NP0051	Grip NP Abutment 1mm
NP0052	Grip NP Abutment 2mm
NP0053	Grip NP Abutment 3mm
NP0054	Grip NP Abutment 4mm
NP0055	Grip NP Abutment 5mm
NP0056	Grip NP Abutment 6mm



Grip™ per TMA

TM0100

Vite RS3404 inclusa











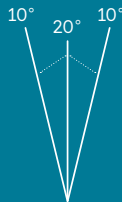

Grip™ per Bar, M2 thread

RS0101

Cappette ritentive		housing		RS6426
		processing		
		extra light		
		light		
		regular		
		Spaziatore		

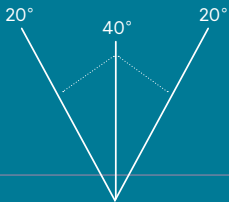
Grip™ Cappette ritentive angolazioni estese		housing		RS6427
		processing		
		zero		
		extra light		
		light		
		regular		
		Spaziatore		

Confezione di vendita

	Cappetta in metallo 4 x confezione	RS6413			
			extra light	Grip™ Cappette ritentive 4 x confezione	RS6417
			light		RS6418
			regular		RS6419
			zero	Cappette ritentive angolazioni estese 4 x confezione	RS6420
			extra light		RS6421
			light		RS6422
			regular		RS6423

Grip™ componenti

	Transfer 4 x confezione	RS6414		Grip Analogo 4 x confezione	RS2508
	Cappette da lab. 4 x confezione	RS6415		Spaziatore 4 x confezione	RS6424
	Cappette da lab. 20 x confezione	RS6416			



Grip™ inseritore

RS6200



Chirurgia Guidata

Adinguide™ è stato creato per offrire al professionista la possibilità di espandere l'attività della propria clinica e dare una risposta alle esigenze contemporanee.

I kit di chirurgia guidata Adin sono stati progettati per mettere in pratica procedure semplici e precise, al fine di garantire un posizionamento dell'impianto in totale sicurezza.

L'innovativa tecnologia di irrigazione "ActiveFlow" migliora il raffreddamento del sito implantare in presenza di una dima chirurgica.

Le frese Adinguide sono progettate con canali intagliati che permettono alla soluzione fisiologica di defluire attraverso la boccia per garantire una migliore irrigazione e ridurre il surriscaldamento osseo.

Il nostro kit di frese, dal design esclusivo, è intuitivo e facile da usare in base al diametro e alla lunghezza dell'impianto.

Il mucotomo consente un facile accesso senza lembo e la fresa pilota regolarizza le creste frastagliate.

Frese auto-centranti – gli stop, di diametro 5.5 e 3.3, presenti sulla parte alta delle frese, ingaggiano la boccia prima ancora che l'apice possa toccare l'osso.

Questo sistema garantisce un posizionamento corretto della fresa, oltre che una precisa e accurata osteotomia alla profondità desiderata.



Kit Chirurgia Guidata
CloseFit™ NP/UNP Frese e Strumentario
GSK002



Procedura guidata completa:



CloseFit™ UNP/NP



Boccola impianti narrow 3.3mmD
GS0033

1

GSN3033



Mucotomo Narrow 3.0mmD, S-3.3

2

GSN0625



Fresa Pilota S-3.3, 2.5/1.8mmDx6.0mmL

3

GSN1025



Fresa S-3.3, 2.5/1.8mmDx10.0mmL

4

GSN1125



Fresa S-3.3, 2.5/1.8mmDx11.5mmL

5

GSN1325



Fresa S-3.3, 2.5/1.8mmDx13.0mmL

6

GSN1625



Fresa S-3.3, 2.5/1.8mmDx16.0mmL

7

GS1915



Fresa per vite di ancoraggio S-2.0, 2.0/1.5mmDx19mmL

8

GS1917



Fresa per vite di ancoraggio S-2.0, 2.0/1.7mmDx19mmL

9

GS0028



Driver da contrangolo per vite di ancoraggio

10

GS0018



UNP Mount per contrangolo per Guidata S-3.3

11

GS0016



UNP Mount per cricchetto per Guidata S-3.3

12

GS0014



UNP Mount per cricchetto per Guidata S-3.3, Screw Retained

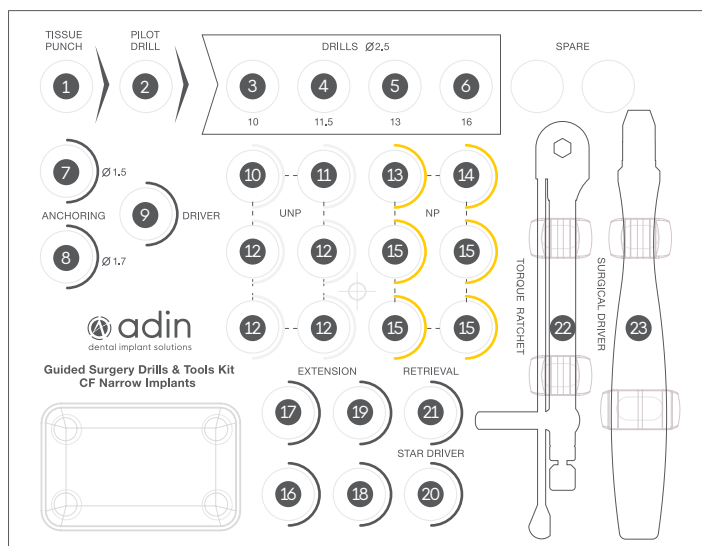

13

GS0017



NP Mount per contrangolo per Guidata S-3.3

14

GS0019



NP Mount per cricchetto per Guidata S-3.3

15

GS0013



NP Mount per cricchetto per Guidata S-3.3, Screw Retained

16

GS0023



Prolunga da cricchetto L10.5

17

GS0024



Prolunga da cricchetto L14.5

18

GS0021



Prolunga da contrangolo per mount L10.5

19

RS9027



Prolunga per fresa

20

RP0004



Driver Manuale Star - Long

21

GS0045



NP&UNP Driver di recupero da cricchetto

22

GS6111



Cricchetto Chirurgico Dinamometrico 35-100 Ncm per esagono 4mm

23

GS0027



Cacciavite Chirurgico per Guidata

Prodotti aggiuntivi Venduti separatamente

Accessori



2.0mm Boccola per vite di ancoraggio

Codice Art. GS0020



Boccola impianti Narrow 3.3mmD

Codice Art. GS0033



2.0D 19mmL Boccola ancoraggio





Codice Art. GS1920



Pin crestale S-3.3

Codice Art. GS0006

Opzioni di acquisto

Codice Art.	Descrizione	Contenuto	Unità per confezione
GS0006	Pin crestale S-3.3		x 3
GS1920	2.0mmD Boccola ancoraggio		x 1
GS0033	3.3mmD Boccola Impianti Narrow		x 1
GS0020	2.0mm Boccola per vite di ancoraggio		x 1

Frese 18mm



Fresa S-3.3, 2.5/1.8mmDx18.0mmL

Codice Art. GSN1825



CloseFit™

Regular & Wide

CloseFit™ RP

Piattaforma Regular

Conicità inversa
Platform Switching
Integrato

Micro anelli coronali

Spira trapezoidale
a disegno variabile
doppio passo
2.4mm (2×1.2)

Automaschiante
Osteocondensante
Ridirezionabile in fase
di inserimento

Apice piatto
attivo

CloseFit™ WP

Piattaforma Wide

Conicità inversa
Platform Switching
Integrato

Micro anelli coronali

Spira trapezoidale
a disegno variabile
doppio passo
2.4mm (2×1.2)

Automaschiante
Osteocondensante
Ridirezionabile in fase
di inserimento

Apice piatto
attivo

CloseFit™ - Regular & Wide

CloseFit™ Regular e Wide sono impianti realizzati con piattaforma protesica conica e serraggio a vite. Idonei al carico immediato in tutti i tipi di osso, possono essere utilizzati sia in mascella che in mandibola. La porzione coronale a conicità inversa, riduce drasticamente la compressione del modulo crestale favorendo la rigenerazione tissutale fisiologica con il miglior risultato estetico.

Superficie OsseoFix™

Titanio grado 23 (Ti 6Al 4V ELI)

CloseFit™ RP - Piattaforma Regular		
Lunghezza	Ø 3.5 mm	
8 mm	ISPX0835	
10 mm	ISPX1035	
11.5 mm	ISPX1135	
13 mm	ISPX1335	
16 mm	ISPX1535	
18 mm	ISPX1835	

CloseFit™ WP - Piattaforma Wide		
Lunghezza	Ø 4.3 mm	Ø 5.0 mm
8 mm	ISPX0843	ISPX0849
10 mm	ISPX1043	ISPX1049
11.5 mm	ISPX1143	ISPX1149
13 mm	ISPX1343	ISPX1349
16 mm	ISPX1543	ISPX1549
18 mm	ISPX1843	ISPX1849

Protocollo di Foratura CloseFit[™] - OSSO SPONGIOSO

Diametro Impianto	Osso Spongioso	NOTE
3.50	2.0	PREPARARE A TUTTA LUNGHEZZA
	2.8	PREPARARE A TUTTA LUNGHEZZA
	3.2 (2/3)	PREPARARE 2/3 LUNGHEZZA
4.30	2.0	PREPARARE A TUTTA LUNGHEZZA
	2.8	PREPARARE A TUTTA LUNGHEZZA
	3.2*	PREPARARE A TUTTA LUNGHEZZA PER IMPIANTI FINO A 13mm PER IMPIANTI 15/18mm PREPARARE SOLO 2/3
	3.6 (2/3)	PREPARARE 2/3 LUNGHEZZA
5.00	2.0	PREPARARE A TUTTA LUNGHEZZA
	2.8	PREPARARE A TUTTA LUNGHEZZA
	3.2	PREPARARE A TUTTA LUNGHEZZA
	3.6	PREPARARE A TUTTA LUNGHEZZA
	4.2*	PREPARARE A TUTTA LUNGHEZZA PER IMPIANTI FINO A 11.5mm PER IMPIANTI 13/15/18mm PREPARARE SOLO 2/3
	4.6 (2/3)	PREPARARE 2/3 LUNGHEZZA

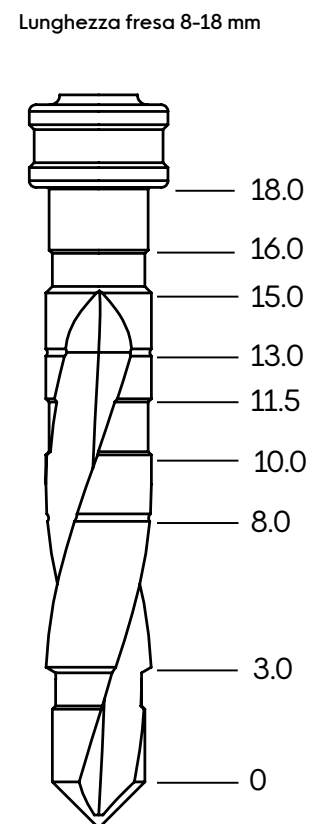

ATTENZIONE

Tutte le misure sono rappresentate in mm.

Nella preparazione del sito implantare considerare che la fresa è 1 mm più lunga della misura dell'impianto.

Protocollo di Foratura CloseFit[™] - OSSO COMPATTO

Diametro Impianto	OssO Compatto	NOTE
3.50	2.0	PREPARARE A TUTTA LUNGHEZZA
	2.8	PREPARARE A TUTTA LUNGHEZZA
	3.2 (2/3)	PREPARARE 2/3 LUNGHEZZA
4.30	2.0	PREPARARE A TUTTA LUNGHEZZA
	2.8	PREPARARE A TUTTA LUNGHEZZA
	3.2*	PREPARARE A TUTTA LUNGHEZZA PER IMPIANTI FINO A 15mm PER IMPIANTI 18mm PREPARARE SOLO 2/3
	3.6*	PREPARARE A TUTTA LUNGHEZZA PER IMPIANTI FINO A 11.5mm PER IMPIANTI 13/16/18mm PREPARARE SOLO 2/3
5.00	2.0	PREPARARE A TUTTA LUNGHEZZA
	2.8	PREPARARE A TUTTA LUNGHEZZA
	3.2	PREPARARE A TUTTA LUNGHEZZA
	3.6	PREPARARE A TUTTA LUNGHEZZA
	4.2*	PREPARARE A TUTTA LUNGHEZZA PER IMPIANTI FINO A 13mm PER IMPIANTI 16/18mm PREPARARE SOLO 2/3
	4.6 (2/3)	PREPARARE 2/3 LUNGHEZZA

Lunghezza fresa 8-18 mm

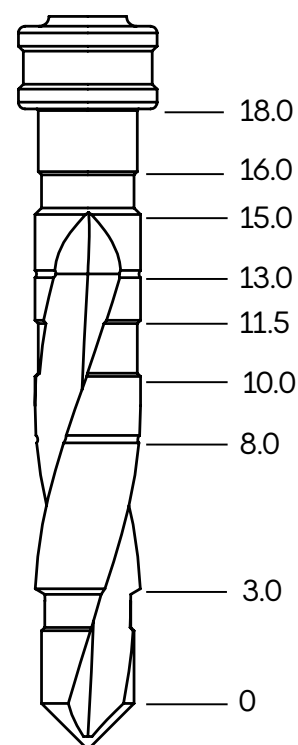

ATTENZIONE

Tutte le misure sono rappresentate in mm.

Nella preparazione del sito implantare considerare che la fresa è 1 mm più lunga della misura dell'impianto.

Viti di Guarigione RP & WP

Torque raccomandato 15(Ncm)

RP CloseFit™ Vite Tappo Conica



RP0073

WP CloseFit™ Vite Tappo Conica



WP0073

RP CloseFit™ Vite di Guarigione

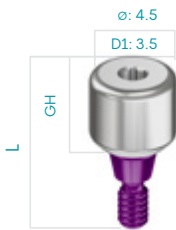

RP0022, GH2/L6.8

RP0023, GH3/L7.8

RP0024, GH4/L8.8

RP0025, GH5/L9.8

RP0026, GH6/L10.8

WP CloseFit™ Vite di Guarigione

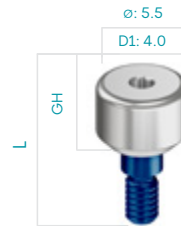

WP0022, GH2/L7.3

WP0023, GH3/L8.3

WP0024, GH4/L9.3

WP0025, GH5/L10.3

WP0026, GH6/L11.3

RP CloseFit™ Vite di Guarigione Slim

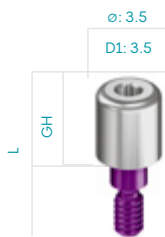

RP0046, GH2/L6.8

RP0047, GH3/L7.8

RP0048, GH4/L8.8

RP0049, GH5/L9.8

RP0050, GH6/L10.8

WP CloseFit™ Vite di Guarigione Slim



WP0046, GH2/L7.3

WP0047, GH3/L8.3

WP0048, GH4/L9.3

WP0049, GH5/L10.3

WP0050, GH6/L11.3

RP CloseFit™ Vite di Guarigione Conica



RP0090, GH2/L7.2

RP0091, GH3/L8.2

RP0092, GH4/L9.2

RP0093, GH5/L10.2

RP0094, GH6/L11.2

WP CloseFit™ Vite di Guarigione Conica



WP0090, GH2/L7.9

WP0091, GH3/L8.9

WP0092, GH4/L9.9

WP0093, GH5/L10.9

WP0094, GH6/L11.9

Frese Tri-Step

L	Ø		Misura	Codice Art.
	1.8-3.2		short	TD1511
	1.8-3.2		long	TD2218

Frese Twist Step

L	Ø		Colore	Codice Art.
<p>short</p> <p>6-13mm</p>	2.0		white	DL1320
	1.8-2.5		purple	DL1325
	2.3-2.8		red	DL1328
	2.8-3.2		blue	DL1332
	3.2-3.6		green	DL1336
	3.8-4.2		black	DL1342
	4.2-4.6		yellow	DL1346
	4.8-5.2		brown	DL1352
	5.2-5.6		grey	DL1356

L	Ø		Colore	Codice Art.
<p>long</p> <p>8-18mm</p>	2.0		white	DL1820
	1.8-2.5		purple	DL1825
	2.3-2.8		red	DL1828
	2.8-3.2		blue	DL1832
	3.2-3.6		green	DL1836
	3.8-4.2		black	DL1842
	4.2-4.6		yellow	DL1846
	4.8-5.2		brown	DL1852
	5.2-5.6		grey	DL1856

Strumentario Chirurgico RP & WP

		Codice Art.
	Cricchetto Chirurgico Dinamometrico 35-100 Ncm	RS6111
	Cricchetto	RS6100
	Cacciavite Chirurgico	RS7001
	Sonda di Profondità	RS6180

	Adattatore Driver per Cricchetto 16.7mm	RA0050		Prolunga per frese	RS9027		Pin di Parallelismo 11mm	RS6150		Pin di Parallelismo 16mm	RS6155
---	--	--------	---	-----------------------	--------	---	--------------------------------	--------	---	--------------------------------	--------

RP 2.2mm Driver
Esagonale per
Cricchetto
Short 20.0L



RP0067

RP 2.2mm Driver
Esagonale per
Cricchetto -Long 25.0L



RP0066

Driver per Cricchetto
per Attacco a sfera
24.4mm



RS6090

WP 2.6mm
Driver per Cricchetto
Short 20.0L



WP0067

WP 2.6mm
Driver per Cricchetto
- Long 25.0L



WP0066

RP 2.25mm Adattatore
Esagonale per
Contrangolo
Short 23.7L



RP0068

RP 2.25mm Adattatore
Esagonale per
Contrangolo
Medium 27.6L



RP0071

RP 2.25mm Adattatore
Esagonale per
Contrangolo
Long 36.0L



RP0074

WP 2.65mm
Adattatore Esagonale
per Contrangolo
Short



WP0068

WP 2.65mm Adattatore
Esagonale per
Contrangolo
Medium



WP0071

WP 2.65mm Adattatore
Esagonale per
Contrangolo
Long



WP0074

Strumentario Protesico RP & WP







Cricchetto







Cricchetto Protesico
Dinamometrico 15-35 Ncm



RS6112

Star (Per TMA angolato/Vite protesica TMA/Componenti protesiche CloseFit)

	Driver per Cricchetto Star Short 20.40L	RP0065		Driver per Cricchetto Star - Long 25.4L	RP0005		Driver Manuale Star - Short 23.4L	RP0064		Driver Manuale Star - Long 23.4L	RP0004
	Driver per Contrangolo Star - Short 25.0L	RP0018		Driver per Contrangolo Star - Long 30.0L	RP0019						

Driver TMA Dritti

	TMA Driver Esagonale per Cricchetto - Short 20.0L	RS6197		TMA Driver Esagonale Manuale - Short 22.4L	RS6193		TMA Driver Esagonale Manuale Long 28.4L	RS6191
	Adattatore Esagonale per Contrangolo - Short 20.0L	RS6194		Adattatore Esagonale per Contrangolo - Long 25.0L	RS6195A			

Viti		L	Ø	Codice Art.
	RP Vite Recupero per Abutment	12.60	2.25	RP3401
	WP Vite Recupero per Abutment	12.30	2.55	WP3401

Presca d'impronta

Torque raccomandato 15(Ncm)



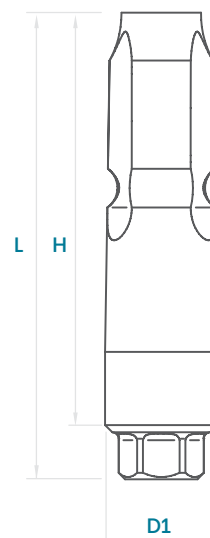

I componenti per la presa d'impronta sono compatibili con tutti i tipi di restauri e sono adatti per le procedure analogiche e digitali, sia a livello implantare che a livello dell'abutment.

L'ampia gamma di soluzioni protesiche consente una pianificazione semplice ma al tempo stesso accurata, dal dente singolo al full-arch.



RP Transfer & Analoghi (A livello dell'impianto)

RP™ Transfer		L	∅	D1	H	Codice Art.
	RP Transfer a Cucchiaino Chiuso Slim - Short	11.2	3.6	2.9	9.0	RP5109
	RP Transfer a Cucchiaino Chiuso Slim - Long	15.2	3.6	2.9	13.0	RP5113
	RP Transfer a Cucchiaino Chiuso - Short	11.20	4.25	2.90	9.0	RP5209
	RP Transfer a Cucchiaino Chiuso - Long	15.20	4.25	2.90	13.0	RP5213
	RP Transfer a Cucchiaino Aperto Slim - Short	14.20	5.00	2.90	10.0	RP5610
	RP Transfer a Cucchiaino Aperto Slim - Long	18.20	5.00	2.90	14.0	RP5614
	RP Transfer a Cucchiaino Aperto - Short	14.20	5.00	2.90	10.0	RP5510
	RP Transfer a Cucchiaino Aperto - Long	18.20	5.00	2.90	14.0	RP5514

RP™ Viti Transfer		L	∅	Codice Art.
	RP Vite per Transfer a Cucchiaino Aperto - Short	24.00	3.10	RP5010
	RP Vite per Transfer a Cucchiaino Aperto - Long	28.00	3.10	RP5014
	RP Vite per Transfer a Cucchiaino Chiuso - Short	16.00	2.80	RP5126
	RP Vite per Transfer a Cucchiaino Chiuso - Long	20.00	2.80	RP5127

RP™ Analogo		L	∅	D1	Codice Art.
	RP Analogo Impianto	12.60	3.55	2.90	RP0007

WP Transfer & Analoghi (A livello dell'impianto)

WP™ Transfer		L	∅	D1	H	Codice Art.
	WP Transfer a Cucchiaino Chiuso Slim - Short	11.30	4.00	3.35	9.00	WP5109
	WP Transfer a Cucchiaino Chiuso Slim - Long	15.30	4.00	3.35	13.00	WP5113
	WP Transfer a Cucchiaino Chiuso - Short	11.30	5.20	3.35	9.00	WP5209
	WP Transfer a Cucchiaino Chiuso - Long	15.30	5.20	3.35	13.00	WP5213
	WP Transfer a Cucchiaino Chiuso Wide - Short	11.30	6.00	3.35	9.00	WP5309
	WP Transfer a Cucchiaino Chiuso Wide - Long	15.30	6.00	3.35	13.00	WP5313
	WP Transfer a Cucchiaino Aperto Slim - Short	14.30	6.00	3.35	10.00	WP5610
	WP Transfer a Cucchiaino Aperto Slim - Long	18.30	6.00	3.35	14.00	WP5614
	WP Transfer a Cucchiaino Aperto - Short	14.30	5.20	3.35	10.00	WP5510
	WP Transfer a Cucchiaino Aperto - Long	18.30	5.20	3.35	14.00	WP5514
	WP Transfer a Cucchiaino Aperto Wide - Short	14.30	6.00	3.35	10.00	WP5410
	WP Transfer a Cucchiaino Aperto Wide - Long	18.30	6.00	3.35	14.00	WP5414







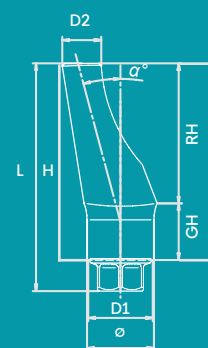

WP™ Viti Transfer		L	∅	Codice Art.
	WP Vite per Transfer a Cucchiaino Aperto - Short	24.00	3.10	WP5010
	WP Vite per Transfer a Cucchiaino Aperto - Long	28.00	3.10	WP5014
	WP Vite per Transfer a Cucchiaino Chiuso - Short	16.50	3.10	WP5126
	WP Vite per Transfer a Cucchiaino Chiuso - Long	20.00	3.10	WP5127

WP™ Analogo		L	∅	D1	Codice Art.
	WP Analogo Impianto	13.10	4.00	3.35	WP0007

Protesi cementata

Torque raccomandato 35(Ncm)



RP™ Protesi cementata		L	∅	D1	D2	H	GH	RH	Codice Art.
	RP Abutment Dritto Slim Senza Spalla	11.00	4.00	2.90	2.95	8.80	2.80	6.00	RP0020
	RP Abutment Dritto Estetico	9.70	4.40	2.90	3.00	7.50	1.00	6.50	RP0012
		10.70	4.40	2.90	3.00	8.50	2.00	6.50	RP0011
		11.70	4.40	2.90	3.00	9.50	3.00	6.50	RP0010
	RP Abutment Estetico Angolato 15°	9.70	4.40	2.90	2.34	7.50	1.00	6.50	RP0013
		10.70	4.40	2.90	2.34	8.50	2.00	6.50	RP0014
		11.70	4.40	2.90	2.34	9.70	3.00	6.50	RP0015
	RP Abutment Angolato 25°	9.3	4.5	-	2.8	7.1	1.00	6.1	RP0251
		10.3	4.5	-	2.8	8.1	2.00	6.1	RP0252
		11.3	4.5	-	2.8	9.1	3.00	6.1	RP0253
	RP Abutment Angolato 35°	9.3	4.5	-	2.8	7.1	1.00	6.1	RP0351
		10.3	4.5	-	2.8	8.1	2.00	6.1	RP0352
		11.3	4.5	-	2.8	9.1	3.00	6.1	RP0353
	RP Abutment Provvisorio Anti-Rotazionale	12.65	3.70	2.90	3.40	10.45	1.00	9.45	RP0043
	RP Abutment Provvisorio Rotazionale	12.65	3.70	2.90	3.40	10.45	1.00	9.45	RP0044
	RP Abutment Cilindrico Calcinabile Anti-rotazionale	12.70	3.70	2.90	3.00	10.50	1.00	9.50	RP0045
	RP Abutment Cromo Cobalto/Plastica Anti-Rotazionale	13.70	4.70	2.90	4.70	11.50	1.50	10.00	RP3094
	RP Abutment Cromo Cobalto/Plastica Rotazionale	13.70	4.70	2.90	4.70	11.50	1.36	10.00	RP3100

Vite RP0001 inclusa nella confezione

WP™ Protesi cementata		L	∅	D1	D2	H	GH	RH	Codice Art.
	WP Abutment Dritto Slim Senza Spalla	11.00	4.20	3.35	3.36	8.70	2.70	6.00	WP0020
	WP Abutment Dritto	9.80	5.05	3.35	3.57	7.50	1.00	6.50	WP0012
		10.80	5.05	3.35	3.57	8.50	2.00	6.50	WP0011
		11.80	5.05	3.35	3.57	9.50	3.00	6.50	WP0010
	WP Abutment Angolato 15°	9.80	5.05	3.35	2.61	7.50	1.00	6.50	WP0013
		10.80	5.05	3.35	2.61	8.50	2.00	6.50	WP0014
		11.80	5.05	3.35	2.61	9.50	3.00	6.50	WP0015
	WP Abutment Angolato 25°	9.3	5	-	3.1	7	1.00	6.00	WP0251
		10.3	5	-	3.1	8	2.00	6.00	WP0252
		11.3	5	-	3.1	9	3.00	6.00	WP0253
	WP Abutment Angolato 35°	9.3	5	-	3.1	7	1.00	6.00	WP0351
		10.3	5	-	3.1	8	2.00	6.00	WP0352
		11.3	5	-	3.1	9	3.00	6.00	WP0353
	WP Abutment Provvisorio Anti- Rotazionale	12.65	4.20	3.35	3.90	10.35	0.90	9.45	WP0043
	WP Abutment Provvisorio Rotazionale	12.65	4.20	3.35	3.90	10.35	0.90	9.45	WP0044
	WP Abutment Calcinabile Cilindrico	12.65	4.20	3.35	3.40	10.35	0.90	9.45	WP0045
	WP Abutment Cromo Cobalto/ Plastica Anti-Rotazionale	13.80	5.20	3.35	5.20	11.50	1.50	10.00	WP3094
	WP Abutment Cromo Cobalto/ Plastica Rotazionale	13.80	5.20	3.35	5.20	11.50	1.50	10.00	WP3100

Vite WP0001 inclusa nella confezione

CAD CAM

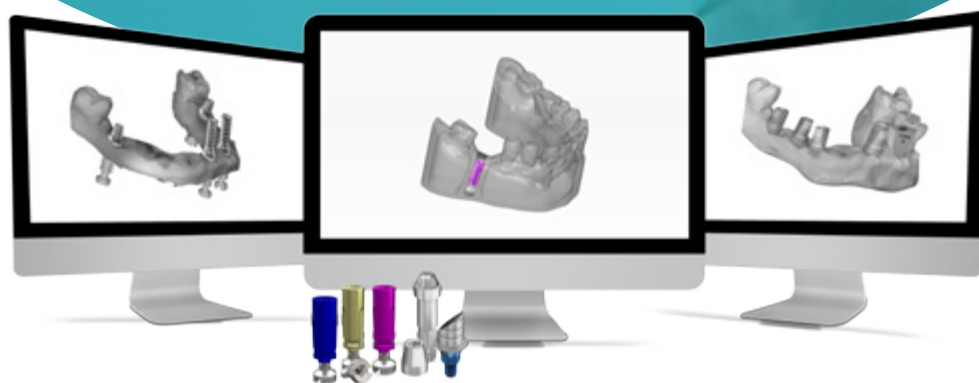

I componenti CAD - CAM e le librerie digitali consentono al Clinico e al Tecnico di creare manufatti protesici di alto livello su impianti Adin, secondo i più attuali protocolli di workflow digitale.

L'ampia gamma di componenti disponibili risponde a qualsiasi esigenza protesica, dal dente singolo a casi di edentulia parziale o totale.

Scan body RP & WP per impianto

Scan body | Per Scanner Intra-orale e da laboratorio

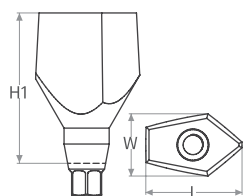

	RP CloseFit™ Scan Body 7mm	RP CloseFit™ Scan Body 10mm	WP CloseFit™ Scan Body 7mm	WP CloseFit™ Scan Body 10mm
Codice Art.	RP0088	RP0089	WP0088	WP0089
Vite di Ritenzione inclusa	RP0001	RP0001	WP0001	WP0001
Materiale	TI 6Al 4V ELI	TI 6Al 4V ELI	TI 6Al 4V ELI	TI 6Al 4V ELI
Misure	H1: 7 mm W: 4.3 mm L: 6.7 mm	H1: 10 mm W: 4.5 mm L: 6.9 mm	H1: 7 mm W: 4.3 mm L: 6.7 mm	H1: 10 mm W: 4.5 mm L: 6.9 mm

Analogo Digitale

RP CloseFit™
Analogo Digitale

WP CloseFit™
Analogo Digitale

Vite di Ritenzione

Codice Art.

RP1000

WP1000

RS1002

Avvitare con Driver
da 1.27 mm

RP™ Ti Base

Anti-Rotazionale

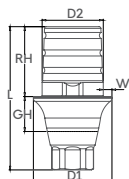

		RH	GH	D1	D2	L	W
TB03411	Ti Base RP Abutment, RH 4mm GH 1mm Anti-Rotazionale	4	1	4.5	3.5	7.2	0.5
TB03421	Ti Base RP Abutment, RH 4mm GH 2mm Anti-Rotazionale	4	2	4.5	3.5	8.2	0.5
TB03431	Ti Base RP Abutment, RH 4mm GH 3mm Anti-Rotazionale	4	3	4.5	3.5	9.2	0.5
TB03441	Ti Base RP Abutment, RH 4mm GH 4mm Anti-Rotazionale	4	4	4.5	3.5	10.2	0.5
TB03611	Ti Base RP Abutment, RH 6mm GH 1mm Anti-Rotazionale	6	1	4.5	3.5	9.2	0.5
TB03621	Ti Base RP Abutment, RH 6mm GH 2mm Anti-Rotazionale	6	2	4.5	3.5	10.2	0.5
TB03631	Ti Base RP Abutment, RH 6mm GH 3mm Anti-Rotazionale	6	3	4.5	3.5	11.2	0.5
TB03641	Ti Base RP Abutment, RH 6mm GH 4mm Anti-Rotazionale	6	4	4.5	3.5	12.2	0.5
TB03811	Ti Base RP Abutment, RH 8mm GH 1mm Anti-Rotazionale	8	1	4.5	3.5	11.2	0.5
TB03821	Ti Base RP Abutment, RH 8mm GH 2mm Anti-Rotazionale	8	2	4.5	3.5	12.2	0.5
TB03831	Ti Base RP Abutment, RH 8mm GH 3mm Anti-Rotazionale	8	3	4.5	3.5	13.2	0.5
TB03841	Ti Base RP Abutment, RH 8mm GH 4mm Anti-Rotazionale	8	4	4.5	3.5	14.2	0.5

Rotazionale

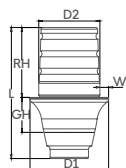

		RH	GH	D1	D2	L	W
TB03412	Ti Base RP Abutment, RH 4mm GH 1mm Rotazionale	4	1	4.5	3.5	6.5	0.5
TB03422	Ti Base RP Abutment, RH 4mm GH 2mm Rotazionale	4	2	4.5	3.5	7.5	0.5
TB03432	Ti Base RP Abutment, RH 4mm GH 3mm Rotazionale	4	3	4.5	3.5	8.5	0.5
TB03442	Ti Base RP Abutment, RH 4mm GH 4mm Rotazionale	4	4	4.5	3.5	9.5	0.5
TB03612	Ti Base RP Abutment, RH 6mm GH 1mm Rotazionale	6	1	4.5	3.5	8.5	0.5
TB03622	Ti Base RP Abutment, RH 6mm GH 2mm Rotazionale	6	2	4.5	3.5	9.5	0.5
TB03632	Ti Base RP Abutment, RH 6mm GH 3mm Rotazionale	6	3	4.5	3.5	10.5	0.5
TB03642	Ti Base RP Abutment, RH 6mm GH 4mm Rotazionale	6	4	4.5	3.5	11.5	0.5
TB03812	Ti Base RP Abutment, RH 8mm GH 1mm Rotazionale	8	1	4.5	3.5	10.5	0.5
TB03822	Ti Base RP Abutment, RH 8mm GH 2mm Rotazionale	8	2	4.5	3.5	11.5	0.5
TB03832	Ti Base RP Abutment, RH 8mm GH 3mm Rotazionale	8	3	4.5	3.5	12.5	0.5
TB03842	Ti Base RP Abutment, RH 8mm GH 4mm Rotazionale	8	4	4.5	3.5	13.5	0.5

Anti-Rotazionale Angolato

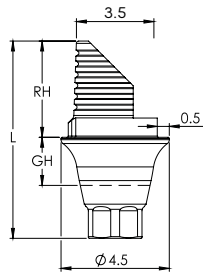

		RH	GH	D1	D2	L	W
TB03413	Ti Base RP Abutment, RH 4mm GH 1mm Anti-Rotazionale Angolato	4	1	4.5	3.5	7.2	0.5
TB03423	Ti Base RP Abutment, RH 4mm GH 2mm Anti-Rotazionale Angolato	4	2	4.5	3.5	8.2	0.5
TB03433	Ti Base RP Abutment, RH 4mm GH 3mm Anti-Rotazionale Angolato	4	3	4.5	3.5	9.2	0.5
TB03613	Ti Base RP Abutment, RH 6mm GH 1mm Anti-Rotazionale Angolato	6	1	4.5	3.5	9.2	0.5
TB03623	Ti Base RP Abutment, RH 6mm GH 2mm Anti-Rotazionale Angolato	6	2	4.5	3.5	10.2	0.5
TB03633	Ti Base RP Abutment, RH 6mm GH 3mm Anti-Rotazionale Angolato	6	3	4.5	3.5	11.2	0.5
TB03813	Ti Base RP Abutment, RH 8mm GH 1mm Anti-Rotazionale Angolato	8	1	4.5	3.5	11.2	0.5
TB03823	Ti Base RP Abutment, RH 8mm GH 2mm Anti-Rotazionale Angolato	8	2	4.5	3.5	12.2	0.5
TB03833	Ti Base RP Abutment, RH 8mm GH 3mm Anti-Rotazionale Angolato	8	3	4.5	3.5	13.2	0.5

Driver ASC

			D1	D2	L	L2
	RP6401	Driver manuale per vite foro angolato Star - Short 23.4 L	9.4	1.4	23.4	9.0
	RP6402	Driver manuale per vite foro angolato Star - Long 28.4 L	9.4	1.4	28.4	14.0
	RP6403	Driver da cricchetto per vite foro angolato Star - Short 17.0 L	7.0	1.4	17.0	11.0
	RP6404	Driver da cricchetto per vite foro angolato Star - Long 22.0 L	7.0	1.4	22.0	16.0
	RP6405	Driver da contrangolo per vite foro angolato Star - Extra Short 20.0 L	2.35	1.4	20.0	7.0
	RP6406	Driver da contrangolo per vite foro angolato Star - Short 25.0 L	2.35	1.4	25.0	12.0
	RP6407	Driver da contrangolo per vite foro angolato Star - Long 30.0 L	2.35	1.4	30.0	17.0

RP™ C-Type Ti Base | Per ulteriori informazioni su prodotto e utilizzo fare riferimento alle IFU028

Anti-Rotazionale

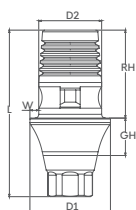

		RH	GH	D1	D2	L	W	Post
TB03414	C-Type Ti Base RP Abutment, GH 1mmAnti-Rotazionale	4.7	1	4.1	3.1	6.8	0.5	Large
TB03424	C-Type Ti Base RP Abutment, GH 2mmAnti-Rotazionale	4.7	2	4.1	3.1	7.3	0.5	Large
TB03434	C-Type Ti Base RP Abutment, GH 3mmAnti-Rotazionale	4.7	3	4.1	3.1	8.3	0.5	Large
TB03444	C-Type Ti Base RP Abutment, GH 4mmAnti-Rotazionale	4.7	4	4.1	3.1	9.3	0.5	Large

Rotazionale

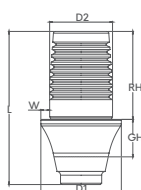

		RH	GH	D1	D2	L	W	Post
TB03415	C-Type Ti Base RP Abutment, GH 1mm Rotazionale	4.7	1	4.1	3.1	6.8	0.5	Large
TB03425	C-Type Ti Base RP Abutment, GH 2mm Rotazionale	4.7	2	4.1	3.1	7.3	0.5	Large
TB03435	C-Type Ti Base RP Abutment, GH 3mm Rotazionale	4.7	3	4.1	3.1	8.3	0.5	Large
TB03445	C-Type Ti Base RP Abutment, GH 4mm Rotazionale	4.7	4	4.1	3.1	9.3	0.5	Large

Ti Blank | Per Medentika PreFace® Holders

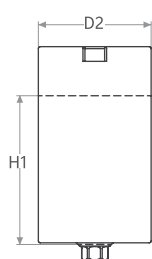

RP CloseFit™
Ti Pre Milled MDTK
Abutment Blank
Ø11.5mm

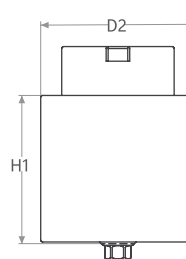

RP CloseFit™
Ti Pre Milled MDTK
Abutment Blank
Ø15.8mm



Codice Art.	RP1211	Codice Art.	RP1215
Vite di Ritenzione inclusa	RP0001	Vite di Ritenzione inclusa	RP0001
Materiale	TI 6Al 4V ELI	Materiale	TI 6Al 4V ELI
Misure	H1: 15.2 mm D2: Ø11.5 mm	Misure	H1: 15.2 mm D2: Ø15.8 mm
Utilizzo	abutment customizzato per elemento singolo	Utilizzo	abutment customizzato per elemento singolo

Vite Abutment

RP CloseFit™
Vite Abutment



Codice Art.	RP0001
Utilizzo	Per RP Scan Body, Ti Base, TiBase angolati e Blank

WP™ Ti Base

Anti-Rotazionale

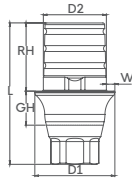

		RH	GH	D1	D2	L	W
TB05411	Ti Base WP Abutment, RH 4mm GH 1mm Anti-Rotazionale	4	1	4.7	3.7	7.3	0.5
TB05421	Ti Base WP Abutment, RH 4mm GH 2mm Anti-Rotazionale	4	2	4.7	3.7	8.3	0.5
TB05431	Ti Base WP Abutment, RH 4mm GH 3mm Anti-Rotazionale	4	3	4.7	3.7	9.3	0.5
TB05441	Ti Base WP Abutment, RH 4mm GH 4mm Anti-Rotazionale	4	4	4.7	3.7	10.3	0.5
TB05611	Ti Base WP Abutment, RH 6mm GH 1mm Anti-Rotazionale	6	1	4.7	3.7	9.3	0.5
TB05621	Ti Base WP Abutment, RH 6mm GH 2mm Anti-Rotazionale	6	2	4.7	3.7	10.3	0.5
TB05631	Ti Base WP Abutment, RH 6mm GH 3mm Anti-Rotazionale	6	3	4.7	3.7	11.3	0.5
TB05641	Ti Base WP Abutment, RH 6mm GH 4mm Anti-Rotazionale	6	4	4.7	3.7	12.3	0.5
TB05811	Ti Base WP Abutment, RH 8mm GH 1mm Anti-Rotazionale	8	1	4.7	3.7	11.3	0.5
TB05821	Ti Base WP Abutment, RH 8mm GH 2mm Anti-Rotazionale	8	2	4.7	3.7	12.3	0.5
TB05831	Ti Base WP Abutment, RH 8mm GH 3mm Anti-Rotazionale	8	3	4.7	3.7	13.3	0.5
TB05841	Ti Base WP Abutment, RH 8mm GH 4mm Anti-Rotazionale	8	4	4.7	3.7	14.3	0.5

Anti-Rotazionale Wide

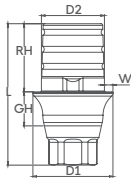

		RH	GH	D1	D2	L	W
TB05411W	Ti Base WP Abutment, RH 4mm GH 1mm Anti-Rotazionale, Wide	4	1	5.5	3.7	7.3	0.9
TB05421W	Ti Base WP Abutment, RH 4mm GH 2mm Anti-Rotazionale Wide	4	2	5.5	3.7	8.3	0.9
TB05431W	Ti Base WP Abutment, RH 4mm GH 3mm Anti-Rotazionale Wide	4	3	5.5	3.7	9.3	0.9
TB05441W	Ti Base WP Abutment, RH 4mm GH 4mm Anti-Rotazionale Wide	4	4	5.5	3.7	10.3	0.9
TB05611W	Ti Base WP Abutment, RH 6mm GH 1mm Anti-Rotazionale Wide	6	1	5.5	3.7	9.3	0.9
TB05621W	Ti Base WP Abutment, RH 6mm GH 2mm Anti-Rotazionale Wide	6	2	5.5	3.7	10.3	0.9
TB05631W	Ti Base WP Abutment, RH 6mm GH 3mm Anti-Rotazionale Wide	6	3	5.5	3.7	11.3	0.9
TB05641W	Ti Base WP Abutment, RH 6mm GH 4mm Anti-Rotazionale Wide	6	4	5.5	3.7	12.3	0.9
TB05811W	Ti Base WP Abutment, RH 8mm GH 1mm Anti-Rotazionale Wide	8	1	5.5	3.7	11.3	0.9
TB05821W	Ti Base WP Abutment, RH 8mm GH 2mm Anti-Rotazionale Wide	8	2	5.5	3.7	12.3	0.9
TB05831W	Ti Base WP Abutment, RH 8mm GH 3mm Anti-Rotazionale Wide	8	3	5.5	3.7	13.3	0.9
TB05841W	Ti Base WP Abutment, RH 8mm GH 4mm Anti-Rotazionale Wide	8	4	5.5	3.7	14.3	0.9

Rotazionale

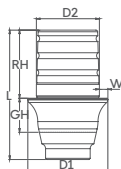

		RH	GH	D1	D2	L	W
TB05412	Ti Base WP Abutment, RH 4mm GH 1mm Rotazionale	4	1	4.7	3.7	6.6	0.5
TB05422	Ti Base WP Abutment, RH 4mm GH 2mm Rotazionale	4	2	4.7	3.7	7.6	0.5
TB05432	Ti Base WP Abutment, RH 4mm GH 3mm Rotazionale	4	3	4.7	3.7	8.6	0.5
TB05442	Ti Base WP Abutment, RH 4mm GH 4mm Rotazionale	4	4	4.7	3.7	9.6	0.5
TB05612	Ti Base WP Abutment, RH 6mm GH 1mm Rotazionale	6	1	4.7	3.7	8.6	0.5
TB05622	Ti Base WP Abutment, RH 6mm GH 2mm Rotazionale	6	2	4.7	3.7	9.6	0.5
TB05632	Ti Base WP Abutment, RH 6mm GH 3mm Rotazionale	6	3	4.7	3.7	10.6	0.5
TB05642	Ti Base WP Abutment, RH 6mm GH 4mm Rotazionale	6	4	4.7	3.7	11.6	0.5
TB05812	Ti Base WP Abutment, RH 8mm GH 1mm Rotazionale	8	1	4.7	3.7	10.6	0.5
TB05822	Ti Base WP Abutment, RH 8mm GH 2mm Rotazionale	8	2	4.7	3.7	11.6	0.5
TB05832	Ti Base WP Abutment, RH 8mm GH 3mm Rotazionale	8	3	4.7	3.7	12.6	0.5
TB05842	Ti Base WP Abutment, RH 8mm GH 4mm Rotazionale	8	4	4.7	3.7	13.6	0.5

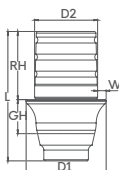

Rotazionale
Wide

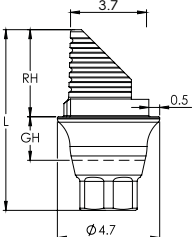

		RH	GH	D1	D2	L	W
TB05412W	Ti Base WP Abutment, RH 4mm GH 1mm Rotazionale Wide	4	1	5.5	3.7	6.6	0.9
TB05422W	Ti Base WP Abutment, RH 4mm GH 2mm Rotazionale Wide	4	2	5.5	3.7	7.6	0.9
TB05432W	Ti Base WP Abutment, RH 4mm GH 3mm Rotazionale Wide	4	3	5.5	3.7	8.6	0.9
TB05442W	Ti Base WP Abutment, RH 4mm GH 4mm Rotazionale Wide	4	4	5.5	3.7	9.6	0.9
TB05612W	Ti Base WP Abutment, RH 6mm GH 1mm Rotazionale Wide	6	1	5.5	3.7	8.6	0.9
TB05622W	Ti Base WP Abutment, RH 6mm GH 2mm Rotazionale Wide	6	2	5.5	3.7	9.6	0.9
TB05632W	Ti Base WP Abutment, RH 6mm GH 3mm Rotazionale Wide	6	3	5.5	3.7	10.6	0.9
TB05642W	Ti Base WP Abutment, RH 6mm GH 4mm Rotazionale Wide	6	4	5.5	3.7	11.6	0.9
TB05812W	Ti Base WP Abutment, RH 8mm GH 1mm Rotazionale Wide	8	1	5.5	3.7	10.6	0.9
TB05822W	Ti Base WP Abutment, RH 8mm GH 2mm Rotazionale Wide	8	2	5.5	3.7	11.6	0.9
TB05832W	Ti Base WP Abutment, RH 8mm GH 3mm Rotazionale Wide	8	3	5.5	3.7	12.6	0.9
TB05842W	Ti Base WP Abutment, RH 8mm GH 4mm Rotazionale Wide	8	4	5.5	3.7	13.6	0.9

Anti-Rotazionale Angolato			RH	GH	D1	D2	L	W
								
TB05413	Ti Base WP Abutment, RH 4mm GH 1mm Anti-Rotazionale Angolato		4	1	4.7	3.7	7.3	0.5
TB05423	Ti Base WP Abutment, RH 4mm GH 2mm Anti-Rotazionale Angolato		4	2	4.7	3.7	8.3	0.5
TB05433	Ti Base WP Abutment, RH 4mm GH 3mm Anti-Rotazionale Angolato		4	3	4.7	3.7	9.3	0.5
TB05613	Ti Base WP Abutment, RH 6mm GH 1mm Anti-Rotazionale Angolato		6	1	4.7	3.7	9.3	0.5
TB05623	Ti Base WP Abutment, RH 6mm GH 2mm Anti-Rotazionale Angolato		6	2	4.7	3.7	10.3	0.5
TB05633	Ti Base WP Abutment, RH 6mm GH 3mm Anti-Rotazionale Angolato		6	3	4.7	3.7	11.3	0.5
TB05813	Ti Base WP Abutment, RH 8mm GH 1mm Anti-Rotazionale Angolato		8	1	4.7	3.7	11.3	0.5
TB05823	Ti Base WP Abutment, RH 8mm GH 2mm Anti-Rotazionale Angolato		8	2	4.7	3.7	12.3	0.5
TB05833	Ti Base WP Abutment, RH 8mm GH 3mm Anti-Rotazionale Angolato		8	3	4.7	3.7	13.3	0.5

Anti-Rotazionale Angolato Wide			RH	GH	D1	D2	L	W
								
TB05413W	Ti Base WP Abutment, RH 4mm GH 1mm Anti-Rotazionale Angolato Wide		4	1	5.5	3.7	7.3	0.9
TB05423W	Ti Base WP Abutment, RH 4mm GH 2mm Anti-Rotazionale Angolato Wide		4	2	5.5	3.7	8.3	0.9
TB05433W	Ti Base WP Abutment, RH 4mm GH 3mm Anti-Rotazionale Angolato Wide		4	3	5.5	3.7	9.3	0.9
TB05613W	Ti Base WP Abutment, RH 6mm GH 1mm Anti-Rotazionale Angolato Wide		6	1	5.5	3.7	9.3	0.9
TB05623W	Ti Base WP Abutment, RH 6mm GH 2mm Anti-Rotazionale Angolato Wide		6	2	5.5	3.7	10.3	0.9
TB05643W	Ti Base WP Abutment, RH 6mm GH 4mm Anti-Rotazionale Angolato Wide		6	4	5.5	3.7	12.3	0.9
TB05813W	Ti Base WP Abutment, RH 8mm GH 1mm Anti-Rotazionale Angolato Wide		8	1	5.5	3.7	11.3	0.9
TB05823W	Ti Base WP Abutment, RH 8mm GH 2mm Anti-Rotazionale Angolato Wide		8	2	5.5	3.7	12.3	0.9
TB05833W	Ti Base WP Abutment, RH 8mm GH 3mm Anti-Rotazionale Angolato Wide		8	3	5.5	3.7	13.3	0.9

Driver ASC			D1	D2	L	L2
	RP6401	Driver manuale per vite foro angolato Star - Short 23.4 L	9.4	1.4	23.4	9.0
	RP6402	Driver manuale per vite foro angolato Star - Long 28.4 L	9.4	1.4	28.4	14.0
	RP6403	Driver da cricchetto per vite foro angolato Star - Short 17.0 L	7.0	1.4	17.0	11.0
	RP6404	Driver da cricchetto per vite foro angolato Star - Long 22.0 L	7.0	1.4	22.0	16.0
	RP6405	Driver da contrangolo per vite foro angolato Star - Extra Short 20.0 L	2.35	1.4	20.0	7.0
	RP6406	Driver da contrangolo per vite foro angolato Star - Short 25.0 L	2.35	1.4	25.0	12.0
	RP6407	Driver da contrangolo per vite foro angolato Star - Long 30.0 L	2.35	1.4	30.0	17.0

WP™ C-Type Ti Base | Per ulteriori informazioni su prodotto e utilizzo fare riferimento alle IFU028

Anti-Rotazionale

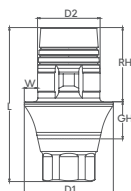

		RH	GH	D1	D2	L	W	Post
TB05414	C-Type Ti Base WP Abutment, GH 1mm Anti-Rotazionale	4	1	4.8	3.37	7.3	0.7	Large
TB05424	C-Type Ti Base WP Abutment, GH 2mm Anti-Rotazionale	4	2	4.8	3.37	8.3	0.7	Large
TB05434	C-Type Ti Base WP Abutment, GH 3mm Anti-Rotazionale	4	3	4.8	3.37	9.3	0.7	Large
TB05444	C-Type Ti Base WP Abutment, GH 4mm Anti-Rotazionale	4	4	4.8	3.37	10.3	0.7	Large

Anti-Rotazionale Wide

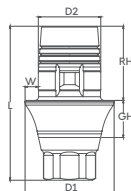

		RH	GH	D1	D2	L	W	Post
TB05414W	C-Type Ti Base WP Abutment, GH 1mm Anti-Rotazionale Wide	4	1	6	3.37	6.6	1.3	Large
TB05424W	C-Type Ti Base WP Abutment, GH 2mm Anti-Rotazionale Wide	4	2	6	3.37	7.6	1.3	Large
TB05434W	C-Type Ti Base WP Abutment, GH 3mm Anti-Rotazionale Wide	4	3	6	3.37	8.6	1.3	Large
TB05444W	C-Type Ti Base WP Abutment, GH 4mm Anti-Rotazionale Wide	4	4	6	3.37	9.6	1.3	Large

Rotazionale

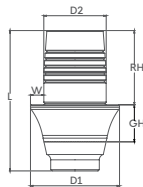

		RH	GH	D1	D2	L	W	Post
TB05415	C-Type Ti Base WP Abutment, GH 1mm Rotazionale	4	1	4.8	3.37	7.3	0.7	Large
TB05425	C-Type Ti Base WP Abutment, GH 2mm Rotazionale	4	2	4.8	3.37	8.3	0.7	Large
TB05435	C-Type Ti Base WP Abutment, GH 3mm Rotazionale	4	3	4.8	3.37	9.3	0.7	Large
TB05445	C-Type Ti Base WP Abutment, GH 4mm Rotazionale	4	4	4.8	3.37	10.3	0.7	Large

Rotazionale Wide

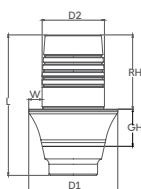

		RH	GH	D1	D2	L	W	Post
TB05415W	C-Type Ti Base WP Abutment, GH 1mm Rotazionale Wide	4	1	6	3.37	6.6	1.3	Large
TB05425W	C-Type Ti Base WP Abutment, GH 2mm Rotazionale Wide	4	2	6	3.37	7.6	1.3	Large
TB05435W	C-Type Ti Base WP Abutment, GH 3mm Rotazionale Wide	4	3	6	3.37	8.6	1.3	Large
TB05445W	C-Type Ti Base WP Abutment, GH 4mm Rotazionale Wide	4	4	6	3.37	9.6	1.3	Large

Ti Blank | Per Medentika PreFace® Holders

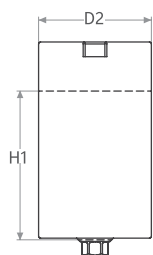

WP CloseFit™
Ti Pre Milled MDTK
Abutment Blank
Ø11.5mm

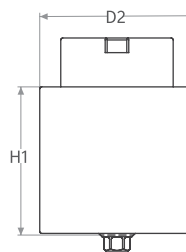

WP CloseFit™
Ti Pre Milled MDTK
Abutment Blank
Ø15.8mm

Codice Art.	WP1311	Codice Art.	WP1315
Vite di Ritenzione inclusa	WP0001	Vite di Ritenzione inclusa	WP0001
Materiale	TI 6Al 4V ELI	Materiale	TI 6Al 4V ELI
Misure	H1: 15.2 mm D2: Ø11.5 mm	Misure	H1: 15.2 mm D2: Ø15.8 mm
Utilizzo	abutment customizzato per elemento singolo	Utilizzo	abutment customizzato per elemento singolo

Vite Abutment

WP CloseFit™
Vite Abutment

Codice Art.	WP0001
Utilizzo	Per WP Scan Body, Ti Base, TiBase angolari e Blank

TMA™ - Multi Unit per RP

Torque raccomandato 35(Ncm)

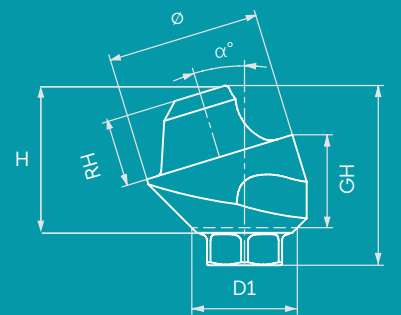

Il Sistema TMA™ per CloseFit RP include abutment dritti e angolati (17°,30°), con ingaggio ad esagono interno in diverse altezze e indice esagonale. Ogni abutment viene fornito completo di portatore che ne agevola il prelevamento e posizionamento.

RP™ TMA dritti		L	Ø	D1	H	GH	RH	Codice Art.
	RP Abutment Transmucoso Dritto 1 mm	4.20	4.90	2.90	2.00	1.00	2.10	RP0032
	RP Abutment Transmucoso Dritto 2 mm	5.20	4.90	2.90	3.00	2.00	2.10	RP0033
	RP Abutment Transmucoso Dritto 3 mm	6.20	4.90	2.90	4.00	3.00	2.10	RP0034
	RP Abutment Transmucoso Dritto 4 mm	7.20	4.90	2.90	5.00	4.00	2.10	RP3729
	RP Abutment Transmucoso Dritto 5 mm	8.20	4.90	2.90	6.00	5.00	2.10	RP3730

RP Viti incluse nella confezione		L	Ø	Codice Art.
	RP Vite di Ritenzione per TMA 1mm	8.00	3.10	RP0039
	RP Vite di Ritenzione per TMA 2mm	9.00	3.10	RP0040
	RP Vite di Ritenzione per TMA 3mm	10.00	3.10	RP0041
	RP Vite di Ritenzione per TMA 4mm	11.00	3.10	RP3409
	RP Vite di Ritenzione per TMA 5mm	12.00	3.10	RP3412





RP™ TMA angolati		L	∅	D1	H	GH	RH	Codice Art.
	RP Abutment Transmucoso Angolato 17° 2.5mm	6.62	4.90	2.90	-	2.58	2.15	RP3734
	RP Abutment Transmucoso Angolato 17° 3.5mm	7.65	4.90	2.90	-	3.68	2.15	RP3737
	RP Abutment Transmucoso Angolato 30° 3mm	6.97	4.90	2.90	-	3.65	2.15	RP3735
	RP Abutment Transmucoso Angolato 30° 4mm	8.00	4.90	2.90	-	4.00	2.15	RP3738

Vite RP3403 inclusa nella confezione

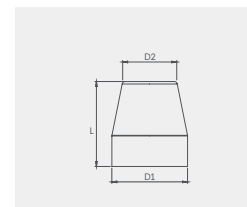
Cappetta di Guarigione		L	D1	D2	Codice Art.
	TMA Cappetta di Guarigione (Vite RS3404 inclusa nella confezione)	5.5	4.9	3.5	RS5005
		7.0	4.9	3.5	RS5003



RP™ Viti		L	∅	Codice Art.
	Vite per TMA Angolato	7.1	2.35	RP3403
	TMA Vite Protesica 15(Ncm)	4.1	2.1	RS3404

TMA™ - Multi Unit per WP

Torque raccomandato 35(Ncm)

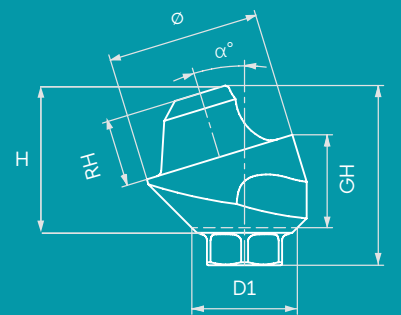

Il Sistema TMA™ per CloseFit WP include abutment dritti e angolati (17°, 30°, 52°, 60°), con ingaggio ad esagono interno in diverse altezze e indice esagonale. Ogni abutment viene fornito completo di portatore che ne agevola il prelevamento e posizionamento.

WP™ TMA dritti		L	Ø	D1	H	GH	RH	Codice Art.
	WP Abutment Transmucoso Dritto 1 mm	4.30	4.90	3.35	2.0	1.0	2.10	WP3731
	WP Abutment Transmucoso Dritto 2 mm	5.30	4.90	3.35	3.0	2.0	2.10	WP3732
	WP Abutment Transmucoso Dritto 3 mm	6.30	4.90	3.35	4.0	3.0	2.10	WP3733
	WP Abutment Transmucoso Dritto 4 mm	7.30	4.90	3.35	5.0	4.0	2.10	WP3729
	WP Abutment Transmucoso Dritto 5 mm	8.30	4.90	3.35	6.0	5.0	2.10	WP3730

Viti incluse nella confezione		L	Ø	Codice Art.
	WP Vite di Ritenzione per TMA	6.50	3.10	WP3406
	WP Vite di Ritenzione per TMA	7.50	3.10	WP3407
	WP Vite di Ritenzione per TMA	8.50	3.10	WP3408
	WP Vite di Ritenzione per TMA	9.50	3.10	WP3409
	WP Vite di Ritenzione per TMA	10.50	3.10	WP3412

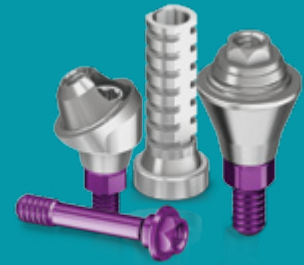



WP™ TMA angolati		L	∅	D1	H	GH	RH	Codice Art.
	WP Abutment Transmucoso Angolato 17° 2.5mm	6.7	4.90	3.35	-	2.54	2.15	WP3734
	WP Abutment Transmucoso Angolato 17° 3.5mm	7.44	4.90	3.35	-	3.56	2.15	WP3737
	WP Abutment Transmucoso Angolato 30° 3mm	6.8	4.90	3.35	-	3.45	2.15	WP3735
	WP Abutment Transmucoso Angolato 30° 4mm	8.04	4.90	3.35	-	4.11	2.15	WP3738
	WP Abutment Transmucoso Angolato 52° 5mm	7.05	3.35	4.9	4.8	4.8	2.1	WP3739
	WP Abutment Transmucoso Angolato 60° 5mm	7.8	3.35	4.9	5.5	5.5	2.1	WP3740

Vite WP3403 inclusa nella confezione

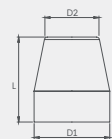
TMA Cappetta di Guarigione		L	D1	D2	Codice Art.
	TMA Cappetta di Guarigione (Vite RS3404 inclusa nella confezione)	5.5	4.9	3.5	RS5005
		7.0	4.9	3.5	RS5003



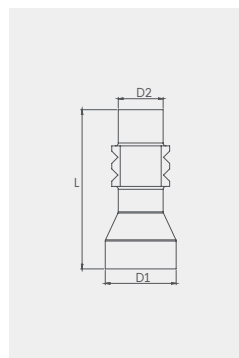

WP™ Viti		L	∅	Codice Art.
	Vite per TMA Angolato	7.1	2.35	WP3403
	TMA Vite Protesica 15(Ncm)	4.1	2.1	RS3404

RP&WP Protesi per TMA™

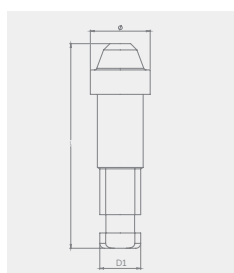

TMA Transfer		L	D1	D2	Codice Art.
	TMA Transfer per Impronta a Cucchiaino Aperto (Vite RS5008 inclusa nella confezione)	11.0	4.9	3.1	RS5006
	TMA Transfer per Impronta a Cucchiaino Chiuso (Vite RS5009 inclusa nella confezione)	8.0	4.9	4.1	RS5011



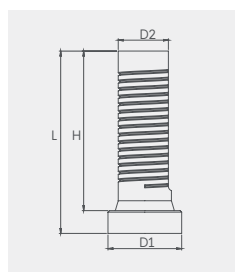

TMA Anologo		L	D1	Codice Art.
	TMA Anologo	16.8	4.9	RS5004



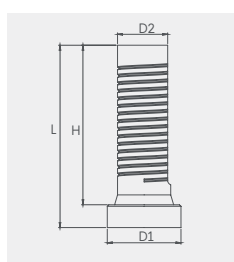

TMA Abutment Calcinabile		L	D1	D2	H	Codice Art.
	TMA Abutment Calcinabile (Vite RS3404 inclusa nella confezione)	12.0	4.9	3.3	10.5	RS5001





TMA Abutment Provvisorio		L	D1	D2	H	Codice Art.
	TMA Abutment Provvisorio in Titanio (Vite RS3404 inclusa nella confezione)	12.0	4.9	3.5	10.5	RS4900

TMA Viti		L	∅	Codice Art.
	TMA Vite per Transfer a Cucchiaino Aperto	14	2.1	RS5008
	TMA Vite per Transfer a Cucchiaino Chiuso	6.8	2.5	RS5009

RP&WP Protesi Digitale per TMA™

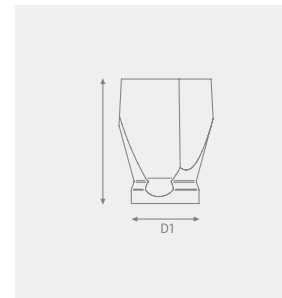

TMA Scan Body		L	D1	Codice Art.
	TMA Scan Body (Vite TM0001 inclusa nella confezione)	6.0	4.9	TM0006
		9.0	4.9	TM0009

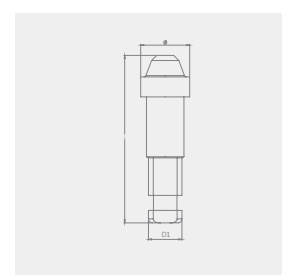

TMA Analogo Modello Digitale		L	D1	D2	Codice Art.
	TMA Analogo Modello Digitale	12.0	4.9	3.35	RS1001



Utilizzare con driver protesico esagonale da 1.27.

TMA Abutment da incollaggio		L	D1	D2	H	W	Codice Art.
	TMA Abutment da incollaggio	4.9	4.9	3.9	3.4	0.5	TM0010
	TMA Abutment da incollaggio, low profile	4.9	5.5	4.5	4.4	0.5	TM0011

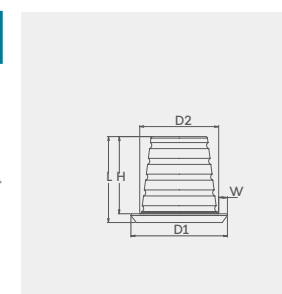

Vite TM0001 inclusa nella confezione

TMA Abutment Provvisorio		L	D1	D2	H	Codice Art.
	TMA Abutment Provvisorio in Titanio (Vite RS3404 inclusa nella confezione)	12.0	4.9	3.5	10.5	RS4900

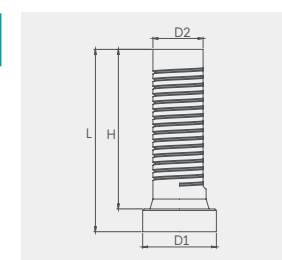

TMA Viti		Codice Art.
	TMA Vite Scan Body	TM0001

Single TMA™ per RP

Torque raccomandato 35(Ncm)

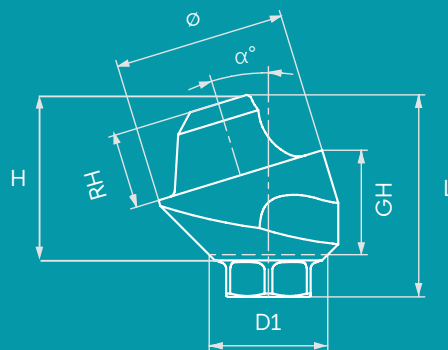

Il sistema STMA (Single Trans Mucosal Abutment) utilizza tutti i vantaggi della linea TMA MultiUnit, consentendo al contempo la precisione e la flessibilità della protesi avvitata su singolo elemento. Il sistema contempla la possibilità di restauri protesici full digital, offrendo una linea di soluzioni esclusive, moderne e complete tale da garantire al professionista la scelta più adeguata per l'ottenimento del miglior risultato estetico..

RP STMA Dritti	L	D1	Ø	GH	RH	Codice Art.
 RP Abutment Dritto Single TMA 1mm	4.2	2.9	4.9	1.0	2.1	RP0032S
RP Abutment Dritto Single TMA 2mm	5.2	2.9	4.9	2.0	2.1	RP0033S
RP Abutment Dritto Single TMA 3mm	6.2	2.9	4.9	3.0	2.1	RP0034S
RP Abutment Dritto Single TMA 4mm	7.2	2.9	4.9	4.0	2.1	RP3729S
RP Abutment Dritto Single TMA 5mm	8.2	2.9	4.9	5.0	2.1	RP3730S



RP Viti incluse nella confezione	L	Ø	Codice Art.
 RP Vite di Ritenzione per TMA 1mm	8.00	3.10	RP0039
 RP Vite di Ritenzione per TMA 2mm	9.00	3.10	RP0040
 RP Vite di Ritenzione per TMA 3mm	10.00	3.10	RP0041
 RP Vite di Ritenzione per TMA 4mm	11.00	3.10	RP3409
 RP Vite di Ritenzione per TMA 5mm	12.00	3.10	RP3412

RP STMA Angolati		L	D1	∅	GH	RH	Codice Art.
	RP Abutment Angolato Single TMA 17° 2.5mm	6.4	2.9	4.9	2.6	2.15	RP3734S
	RP Abutment Angolato Single TMA 30° 3mm	6.9	2.9	4.9	3.7	2.15	RP3735S
	RP Abutment Angolato Single TMA 17° 3.5mm	7.5	2.9	4.9	3.7	2.15	RP3737S
	RP Abutment Angolato Single TMA 30° 4mm	7.3	2.9	4.9	4.0	2.15	RP3738S

Vite RP3403 inclusa nella confezione

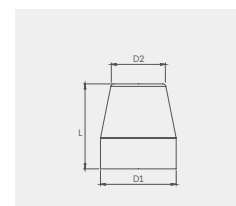
STMA Cappetta di Guarigione		L	D1	D2	Codice Art.
	Single TMA Cappetta di Guarigione (Vite RS3404 inclusa nella confezione)	5.5	4.9	3.5	RS5005S



RP™ Viti		L	∅	Codice Art.
	Vite per TMA Angolato	7.1	2.35	RP3403
	TMA Vite Protesica 15(Ncm)	4.1	2.1	RS3404

Single TMA™ per WP

Torque raccomandato 35(Ncm)

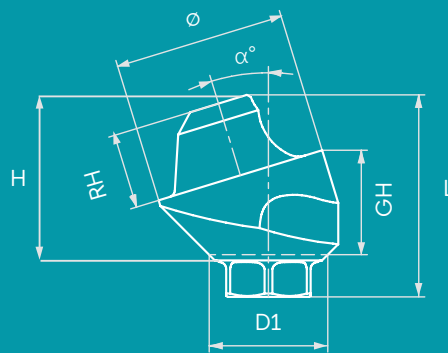

Il sistema STMA (Single Trans Mucosal Abutment) utilizza tutti i vantaggi della linea TMA MultiUnit, consentendo al contempo la precisione e la flessibilità della protesi avvitata su singolo elemento. Il sistema contempla la possibilità di restauri protesici full digital, offrendo una linea di soluzioni esclusive, moderne e complete tale da garantire al professionista la scelta più adeguata per l'ottenimento del miglior risultato estetico..

WP STMA Dritti		L	D1	Ø	GH	RH	Codice Art.
	WP Abutment Dritto Single TMA 1mm	4.3	3.35	4.9	1.0	2.1	WP3731S
	WP Abutment Dritto Single TMA 2mm	5.3	3.35	4.9	2.0	2.1	WP3732S
	WP Abutment Dritto Single TMA 3mm	6.3	3.35	4.9	3.0	2.1	WP3733S
	WP Abutment Dritto Single TMA 4mm	7.3	3.35	4.9	4.0	2.1	WP3729S
	WP Abutment Dritto Single TMA 5mm	8.3	3.35	4.9	5.0	2.1	WP3730S



WP Viti incluse nella confezione		L	Ø	Codice Art.
	WP Vite di Ritenzione per TMA	6.50	3.10	WP3406
	WP Vite di Ritenzione per TMA	7.50	3.10	WP3407
	WP Vite di Ritenzione per TMA	8.50	3.10	WP3408
	WP Vite di Ritenzione per TMA	9.50	3.10	WP3409
	WP Vite di Ritenzione per TMA	10.50	3.10	WP3412

WP STMA Angolati		L	D1	Ø	GH	RH	Codice Art.
	WP Abutment Angolato Single TMA 17° 2.5mm	6.4	3.35	4.9	2.5	2.15	WP3734S
	WP Abutment Angolato Single TMA 30° 3mm	6.8	3.35	4.9	3.5	2.15	WP3735S
	WP Abutment Angolato Single TMA 17° 3.5mm	7.4	3.35	4.9	3.5	2.15	WP3737S
	WP Abutment Angolato Single TMA 30° 4mm	7.5	3.35	4.9	4.1	2.15	WP3738S

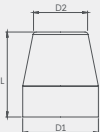

Vite WP3403 inclusa nella confezione

STMA Cappetta di Guarigione		L	D1	D2	Codice Art.
	Single TMA Cappetta di Guarigione (Vite RS3404 inclusa nella confezione)	5.5	4.9	3.5	RS5005S

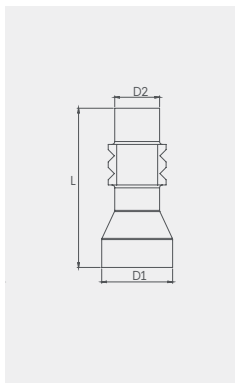

WP™ Viti		L	Ø	Codice Art.
	Vite per TMA Angolato	7.1	2.35	WP3403
	TMA Vite Protesica 15(Ncm)	4.1	2.1	RS3404



STMA Transfer		L	D1	D2	Codice Art.
	Single TMA Transfer per impronta a Cucchiaino Aperto (Vite RS5008 inclusa nella confezione)	11.0	4.9	3.1	RS5006S
	Single TMA Transfer per impronta a Cucchiaino Chiuso (Vite RS5009 inclusa nella confezione)	8.0	4.9	4.1	RS5011S

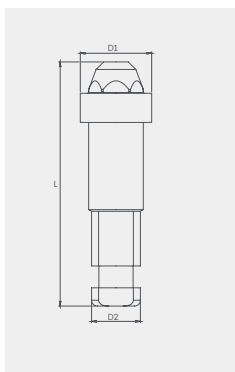

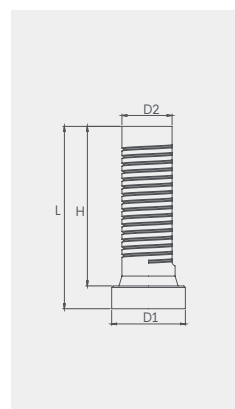

STMA Analogo		L	D1	Codice Art.
	Single TMA Analogo	16.75	4.9	RS5004S



STMA Abutment		L	D1	D2	H	Codice Art.
	Single TMA Abutment Provvisorio in Titanio (Vite RS3404 inclusa nella confezione)	12.0	4.9	3.5	10.5	RS4900S
	Single TMA Abutment Calcinabile con Vite Protetica (Vite RS3404 inclusa nella confezione)	12.0	4.9	3.5	10.35	RS5001S

RP&WP Protesi Digitale per Single TMA™

STMA Scan Body		L	D1	Codice Art.	
	Single TMA Scan Body (Vite TM0001 inclusa nella confezione)	6.0	4.9	TM0006S	
		9.0	4.9	TM0009S	

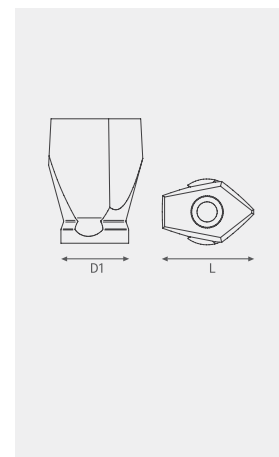

STMA Analogo Modello Digitale		L	D1	D2	Codice Art.
	Single TMA Analogo Modello Digitale	12.0	4.9	3.8	RS1001S

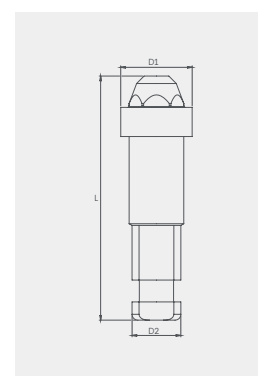

Utilizzare con driver protesico esagonale da 1.27.

STMA Abutment Provvisorio		L	D1	D2	H	Codice Art.
	Single TMA Abutment Provvisorio in Titanio (Vite RS3404 inclusa nella confezione)	12.0	4.9	3.5	10.5	RS4900S

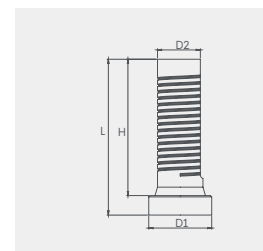

STMA Abutment da incollaggio		L	D1	D2	H	W	Codice Art.
	Single TMA Abutment da incollaggio, low profile (Vite TM0001 inclusa nella confezione)	4.9	5.5	4.5	4.4	0.5	TM0011S

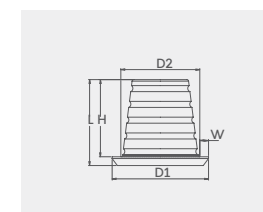

Protesi Overdenture RP/WP

Torque raccomandato 35(Ncm)

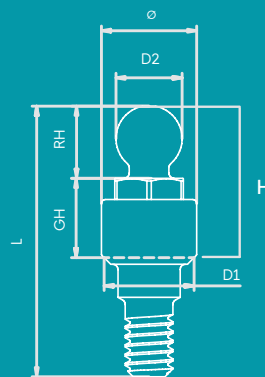

RP Attacco a sfera		L	Ø	D1	D2	H	GH	RH	Codice Art.
	RP Attacco a sfera (Avvitare con RS6090)	8.86	3.10	2.90	2.50	4.00	0.50	3.52	RP0051
		9.32	3.10	2.90	2.50	4.50	1.00	3.52	RP0052
		10.32	3.10	2.90	2.50	5.50	2.00	3.52	RP0053
		11.32	3.10	2.90	2.50	6.50	3.00	3.52	RP0054
		12.32	3.10	2.90	2.50	7.50	4.00	3.52	RP0055
		13.32	3.10	2.90	2.50	8.50	5.00	3.52	RP0056

WP™ Attacco a sfera		L	Ø	D1	D2	H	GH	RH	Codice Art.
	WP Attacco a sfera (Avvitare con RS6090)	9.32	3.50	3.35	2.50	4.00	0.50	2.72	WP0051
		9.82	3.50	3.35	2.50	4.50	1.00	2.72	WP0052
		10.82	3.50	3.35	2.50	5.50	2.00	2.72	WP0053
		11.82	3.50	3.35	2.50	6.50	3.00	2.72	WP0054
		12.82	3.50	3.35	2.50	7.50	4.00	2.72	WP0055
		13.82	3.50	3.35	2.50	8.50	5.00	2.72	WP0056

Cappette per Attacco a sfera		L	Ø	D2	Codice Art.
	Cappetta Bianca per Attacco a sfera (Nylon)	2.60	4.10	3.60	RS2660
	Cappetta Rosa Soft per Attacco a sfera (Nylon)	2.60	4.10	3.60	RS2662
	Cappetta in Titanio per Attacco a sfera	2.90	4.70	4.70	RS2670

Attacco a sfera		L	Ø	D2	GH	RH	Codice Art.
	Analogo Attacco a sfera	16.60	4.00	2.5	0.80	2.7	RS5740

Utilizzare con driver protesico esagonale da 1.27.

Grip™

Attacchi per overdenture

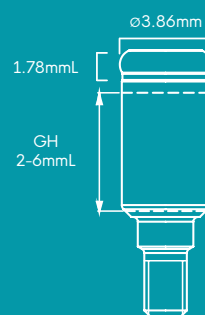
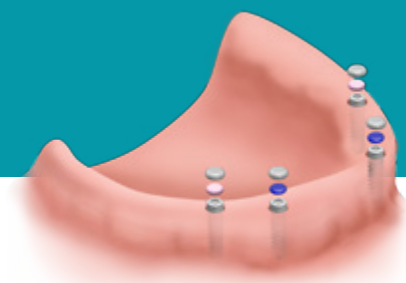

Le protesi overdenture su impianti sono tra le scelte più pratiche per i pazienti che non possono utilizzare restauri fissi. Inoltre, possono rappresentare anche una soluzione provvisoria per i pazienti che attendono il processo di osteointegrazione degli impianti appena inseriti.

Il sistema di attacchi Grip™ rappresenta una risposta versatile, progettata per garantire la massima stabilità della protesi, sia in arcata superiore che inferiore. La vasta gamma di cappette ritentive consente al professionista di individuare la soluzione migliore per ogni singolo caso.

Il sistema di attacchi Grip™ è disponibile in un'ampia gamma di altezze gengivali, in modo da garantire una soluzione sicura e affidabile a lungo termine.

Grip™ componenti



RP CloseFit™ Grip™ abutment

RP0038	Grip RP Abutment 1mm
RP0057	Grip RP Abutment 2mm
RP0058	Grip RP Abutment 3mm
RP0059	Grip RP Abutment 4mm
RP0060	Grip RP Abutment 5mm
RP0061	Grip RP Abutment 6mm



WP CloseFit™ Grip™ abutment retention

WP0063	Grip RP Abutment 1mm
WP0057	Grip RP Abutment 2mm
WP0058	Grip RP Abutment 3mm
WP0059	Grip RP Abutment 4mm
WP0060	Grip RP Abutment 5mm
WP0061	Grip RP Abutment 6mm



Grip™ per TMA

TM0100

Vite RS3404 inclusa











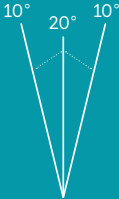

Grip™ per Bar, M2 thread

RS0101

Cappette ritentive		housing		RS6426
		processing		
		extra light		
		light		
		regular		
		Spaziatore		

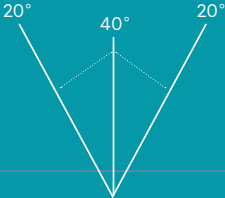
Grip™ Cappette ritentive angolazioni estese		housing		RS6427
		processing		
		zero		
		extra light		
		light		
		regular		
		Spaziatore		

Confezioni di vendita

	Cappetta in metallo 4 unità per confezione	RS6413			
			extra light	Grip™ Cappette ritentive 4 unità per confezione	RS6417
			light		RS6418
			regular		RS6419
			zero	Cappette ritentive angolazioni estese 4 unità per confezione	RS6420
			extra light		RS6421
			light		RS6422
			regular		RS6423

Grip™ componenti

	Transfer 4 unità per confezione	RS6414		Grip Analogo 4 unità per confezione	RS2508
	Cappette da lab. 4 unità per confezione	RS6415		Spaziatore 4 unità per confezione	RS6424
	Cappette da lab. 20 unità per confezione	RS6416			



Grip™ inseritore

RS6200



Chirurgia Guidata

Adinguide™ è stato creato per offrire al professionista la possibilità di espandere l'attività della propria clinica e dare una risposta alle esigenze contemporanee.

I kit di chirurgia guidata Adin sono stati progettati per mettere in pratica procedure semplici e precise, al fine di garantire un posizionamento dell'impianto in totale sicurezza.

L'innovativa tecnologia di irrigazione "ActiveFlow" migliora il raffreddamento del sito implantare in presenza di una dima chirurgica.

Le frese Adinguide sono progettate con canali intagliati che permettono alla soluzione fisiologica di defluire attraverso la boccola per garantire una migliore irrigazione e ridurre il surriscaldamento osseo.

Il nostro kit di frese, dal design esclusivo, è intuitivo e facile da usare in base al diametro e alla lunghezza dell'impianto.

Il mucotomo consente un facile accesso senza lembo e la fresa pilota regolarizza le creste frastagliate.

Frese auto-centranti – gli stop, di diametro 5.5 mm e 3.3 mm, presenti sulla parte alta delle frese, ingaggiano la boccola prima ancora che l'apice possa toccare l'osso.

Questo sistema garantisce un posizionamento corretto della fresa, oltre che una precisa e accurata osteotomia alla profondità desiderata.



Kit Chirurgia Guidata CloseFit™ RP/WP Frese GSK001



Procedura guidata completa:



CloseFit™ RP/WP
Implant Platform



GS Accessori
KIT - RP&WP
GSK004



Boccola 5.5mmD
GS0055



GS5055 Mucotomo 5.0mmD, S-5.5



GS0625 Fresa Pilota S-5.5, 2.5/1.8mmDx6.0mmL



GS0825 Fresa S-5.5, 2.5/1.8mmDx8.0mmL



GS1025 Fresa S-5.5, 2.5/1.8mmDx10.0mmL



GS1125 Fresa S-5.5, 2.5/1.8mmDx11.5mmL



GS1325 Fresa S-5.5, 2.5/1.8mmDx13.0mmL



GS1625 Fresa S-5.5, 2.5/1.8mmDx16.0mmL



GS0632 Fresa S-5.5, 3.2/2.5mmDx6.25mmL



GS0638 Fresa S-5.5, 3.85/3.2mmDx6.25mmL



GS0646 Fresa S-5.5, 4.6/3.85mmDx6.25mmL



GS0832 Fresa S-5.5, 3.2/2.5mmDx8.0mmL



GS0838 Fresa S-5.5, 3.85/3.2mmDx8.0mmL



GS0846 Fresa S-5.5, 4.6/3.85mmDx8.0mmL



GS1032 Fresa S-5.5, 3.2/2.5mmDx10.0mmL



GS1038 Fresa S-5.5, 3.85/3.2mmDx10.0mmL



GS1046 Fresa S-5.5, 4.6/3.85mmDx10.0mmL



GS1132 Fresa S-5.5, 3.2/2.5mmDx11.5mmL



GS1138 Fresa S-5.5, 3.85/3.2mmDx11.5mmL



GS1146 Fresa S-5.5, 4.6/3.85mmDx11.5mmL



GS1332 Fresa S-5.5, 3.2/2.5mmDx13.0mmL



GS1338 Fresa S-5.5, 3.85/3.2mmDx13.0mmL



GS1346 Fresa S-5.5, 4.6/3.85mmDx13.0mmL



GS1632 Fresa S-5.5, 3.2/2.5mmDx16.0mmL



GS1638 Fresa S-5.5, 3.85/3.2mmDx16.0mmL



GS1646 Fresa S-5.5, 4.6/3.85mmDx16.0mmL

Kit Chirurgia Guidata CloseFit™ RP/WP Strumentario GSK004



Procedura guidata completa:



CloseFit™ RP/WP



GS Kit Frese
GSK001



Boccola 5.5mmD
GS0055

1

GS1915



Fresa per vite di ancoraggio S-2.0,
2.0/1.5mmDx19mmL

2

GS1917



Fresa per vite di ancoraggio S-2.0,
2.0/1.7mmDx19mmL

3

GS0028



Driver da contrangolo per vite di ancoraggio

6

GS0037



RP Mount per cricchetto per Guida
S-5.5, Screw Retained

7

GS0046



RP Driver di recupero da cricchetto

4

GS0041



RP Mount per contrangolo per Guida
S-5.5

5

GS0043



RP Mount per cricchetto per Guida
S-5.5

8

GS0042



WP Mount per contrangolo per Guida
S-5.5

9

GS0044



WP Mount per cricchetto per Guida
S-5.5

10

GS0039



WP Mount per cricchetto per Guida
S-5.5, Screw Retained

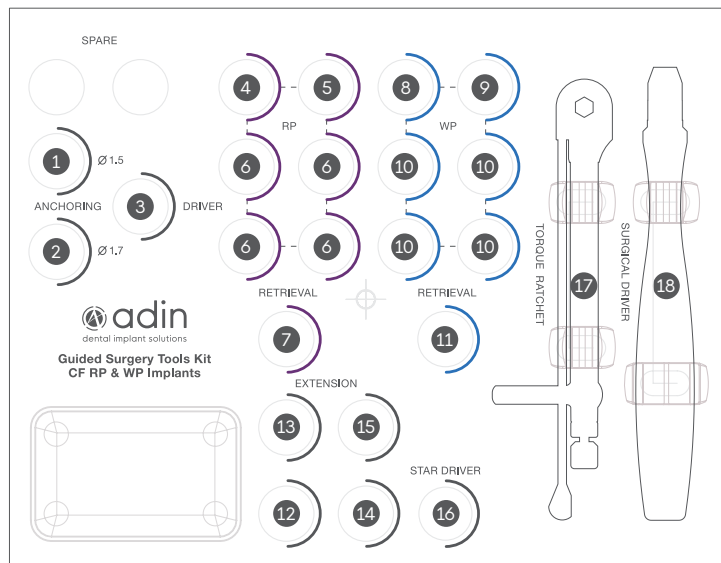

11

GS0047



WP Driver di recupero da cricchetto

14

GS0021



Prolunga da contrangolo per mount L10.5

12

GS0023



Prolunga da cricchetto L10.5

15

RS9027



Prolunga per frese

17

GS6111



Cricchetto Chirurgico Dinamometrico 35-100 Ncm per
esagono 4mm

13

GS0024



Prolunga da cricchetto L14.5

16

RP0004



Driver Manuale Star - Long

18

GS0027



Cacciavite Chirurgico per Guida

Prodotti aggiuntivi Venduti separatamente

Accessori



2.0mm Boccola per vite di ancoraggio

Codice Art. GS0020



3.3mmD Boccola Impianti Narrow

Codice Art. GS0033



5.5mmD Boccola

Codice Art. GS0055



2.0D 19mmL Boccola ancoraggio

Codice Art. GS1920



Pin crestale S-3.3

Codice Art. GS0006



Pin crestale S-5.5

Codice Art. GS0007

Opzioni di acquisto

Codice Art.	Descrizione	Contenuto Confezione	Unità
GS0006	Pin crestale S-3.3		x 3
GS0007	Pin crestale S-5.5		x 3
GS1920	2.0mmD Boccola ancoraggio		x 3
GS0055	5.5mmD Boccola		x 1
GS0020	2.0mm Boccola per vite di ancoraggio		x 3

Frese 18mm



Fresa S-3.3, 2.5/1.8mmDx18.0mmL

Codice Art. GSN1825



UniFit™

Connessione
Conica 7 gradi

Adin presenta UniFit™, la connessione conica 7 gradi e piattaforma protesica unica. UniFit™ rappresenta il massimo risultato ottenuto dagli oltre 30 anni di esperienza in implantologia, la somma delle migliori caratteristiche della gamma implantare Adin.

L'obiettivo di UniFit™ è rendere semplici anche le procedure più complesse. Con Unifit il professionista avrà a disposizione i vantaggi di una piattaforma protesica unica, ciò significa che gli stessi componenti protesici si adattano a ogni impianto della linea implantare, a prescindere da diametro e dimensioni.





UniFit™

Piattaforma protesica unica
con indice direzione 6 posizioni

Platform Switching Integrato

Modulo crestale con
conicità inversa

Micro anelli coronali

Nucleo e corpo conico

Spire trapezoidali a
disegno variabile
doppio passo
2.4mm (2x1.2)

Automaschiante
Osteocondensante
Ridirezionabile in fase
di inserimento

Apice arrotondato
attivo

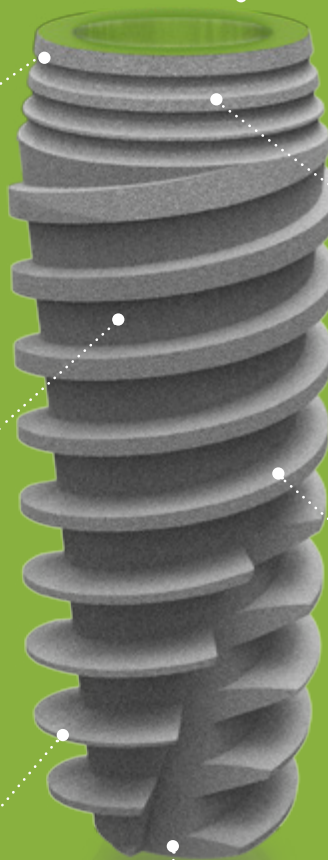

Torque raccomandato fino a 50 Ncm

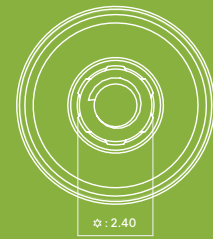

	Ø	L	D1	D3	Art. n°
	3.5	8.0	2.9	2.7	ISPUF0835
		10.0	2.9	2.6	ISPUF1035
		11.5	2.9	2.6	ISPUF1135
		13.0	2.9	2.6	ISPUF1335
		16.0	2.9	2.5	ISPUF1635
		18.0	2.9	2.5	ISPUF1835
	3.75	8.0	2.9	3.2	ISPUF0838
		10.0	2.9	3.1	ISPUF1038
		11.5	2.9	3.1	ISPUF1138
		13.0	2.9	3.1	ISPUF1338
		16.0	2.9	3.0	ISPUF1638
		18.0	2.9	3.0	ISPUF1838
	4.3	6.0	2.9	3.7	ISPUF0643
		8.0	2.9	3.4	ISPUF0843
		10.0	2.9	3.3	ISPUF1043
		11.5	2.9	3.2	ISPUF1143
		13.0	2.9	3.0	ISPUF1343
		16.0	2.9	2.8	ISPUF1643
	5.0	6.0	2.9	4.5	ISPUF0649
		8.0	2.9	4.1	ISPUF0849
		10.0	2.9	4.1	ISPUF1049
		11.5	2.9	4.0	ISPUF1149
		13.0	2.9	3.8	ISPUF1349
		16.0	2.9	3.6	ISPUF1649
	6.0	6.0	2.9	5.5	ISPUF0660
		8.0	2.9	5.2	ISPUF0860
		10.0	2.9	5.2	ISPUF1060
		11.5	2.9	5.1	ISPUF1160
		13.0	2.9	5.1	ISPUF1360

Radiographic Template UniFit | ASD0617



**Connessione Conica 7°
con indice antirotazionale
a stella a 6 posizioni**

La connessione conica 7° con indice antirotazionale a stella a 6 posizioni si traduce in una piattaforma protesica unica che semplifica l'intero flusso di lavoro dell'odontoiatra.

Il design esclusivo del corpo e delle spire consente di ottenere la migliore performance chirurgica in tutti i tipi di osso. La porzione coronale a conicità inversa riduce drasticamente la compressione del modulo crestale favorendo la rigenerazione tissutale fisiologica con il miglior risultato estetico.

UniFit™ presenta la superficie implantare OsseoFix™, un trattamento di superficie esclusivo ad elevato coefficiente idrofilico, arricchito con fosfato di calcio ad alta purezza. Concepita per ottenere un livello ottimale di ruvidità, bioattiva con elevate proprietà osteoconduttive, risulta la superficie ideale per implantologia a carico immediato in osso scarsamente vascolarizzato.

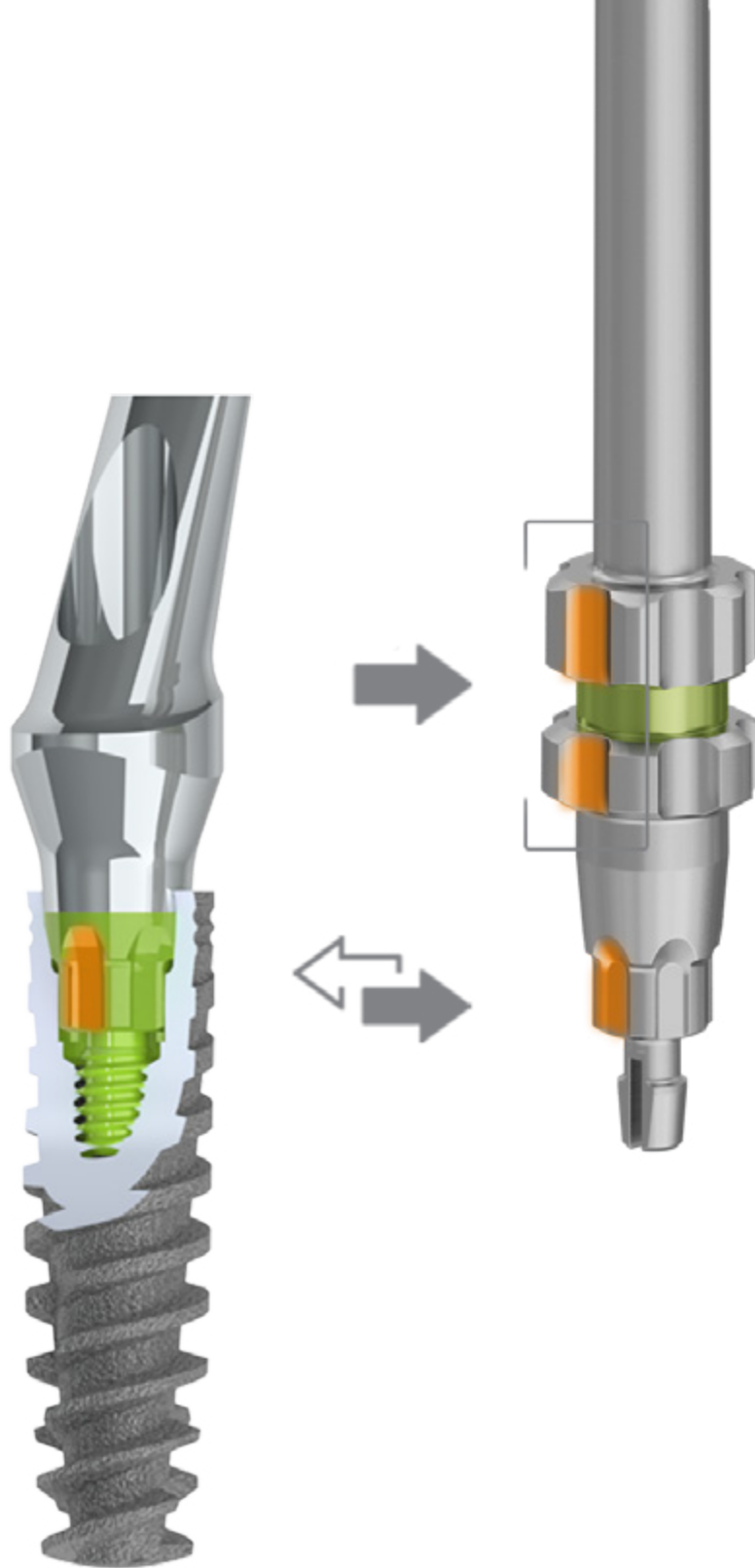

Il design esclusivo della connessione UniFit™ permette un accoppiamento semplice tra impianto e abutment. La connessione a stella garantisce un ingaggio autoguidato attraverso un feedback tattile ben definito.

Protocollo di Foratura UniFit[™] - OSSO SPONGIOSO

Diametro Impianto	Osso Spongioso	NOTE
3.50	2.0	PREPARARE A TUTTA LUNGHEZZA
	2.8	PREPARARE A TUTTA LUNGHEZZA
	3.2 (2/3)	PREPARARE 2/3 LUNGHEZZA
3.75	2.0	PREPARARE A TUTTA LUNGHEZZA
	2.8	PREPARARE A TUTTA LUNGHEZZA
	3.2 (2/3)	PREPARARE 2/3 LUNGHEZZA
	3.6 (2/3)	PREPARARE 2/3 LUNGHEZZA
4.30	2.0	PREPARARE A TUTTA LUNGHEZZA
	2.8	PREPARARE A TUTTA LUNGHEZZA
	3.2	PREPARARE A TUTTA LUNGHEZZA
	3.6 (2/3)	PREPARARE 2/3 LUNGHEZZA
5.00	2.0	PREPARARE A TUTTA LUNGHEZZA
	2.8	PREPARARE A TUTTA LUNGHEZZA
	3.2	PREPARARE A TUTTA LUNGHEZZA
	3.6	PREPARARE A TUTTA LUNGHEZZA
	4.2	PREPARARE A TUTTA LUNGHEZZA
	4.6 (2/3)	PREPARARE 2/3 LUNGHEZZA
6.00	2.0	PREPARARE A TUTTA LUNGHEZZA
	2.8	PREPARARE A TUTTA LUNGHEZZA
	3.2	PREPARARE A TUTTA LUNGHEZZA
	3.6	PREPARARE A TUTTA LUNGHEZZA
	4.2	PREPARARE A TUTTA LUNGHEZZA
	4.6	PREPARARE A TUTTA LUNGHEZZA
	5.2	PREPARARE A TUTTA LUNGHEZZA
	5.6 (2/3)	PREPARARE 2/3 LUNGHEZZA

Lunghezza fresa 8-18 mm

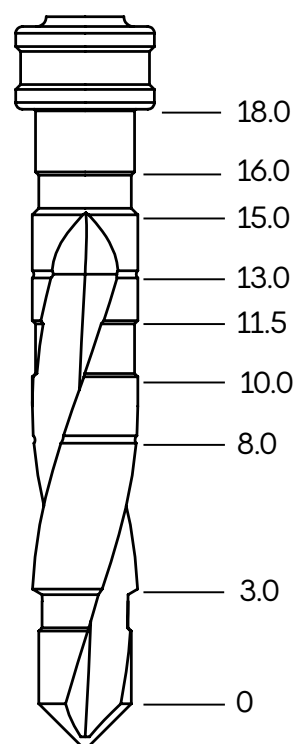

ATTENZIONE

Tutte le misure sono rappresentate in mm.

Nella preparazione del sito implantare considerare che la fresa è 1 mm più lunga della misura dell'impianto.

Protocollo di Foratura UniFit™ - OSSO COMPATTO

Diametro Impianto	Osso Compatto	NOTE
3.50	2.0	PREPARARE A TUTTA LUNGHEZZA
	2.8	PREPARARE A TUTTA LUNGHEZZA
	3.2	PREPARARE A TUTTA LUNGHEZZA
	3.6	PREPARAZIONE CORONALE
3.75	2.0	PREPARARE A TUTTA LUNGHEZZA
	2.8	PREPARARE A TUTTA LUNGHEZZA
	3.2	PREPARARE A TUTTA LUNGHEZZA
	3.6	PREPARARE A TUTTA LUNGHEZZA
4.30	2.0	PREPARARE A TUTTA LUNGHEZZA
	2.8	PREPARARE A TUTTA LUNGHEZZA
	3.2	PREPARARE A TUTTA LUNGHEZZA
	3.6	PREPARARE A TUTTA LUNGHEZZA
	4.2	PREPARAZIONE CORONALE (6mm a tutta lunghezza)
5.00	2.0	PREPARARE A TUTTA LUNGHEZZA
	2.8	PREPARARE A TUTTA LUNGHEZZA
	3.2	PREPARARE A TUTTA LUNGHEZZA
	3.6	PREPARARE A TUTTA LUNGHEZZA
	4.2	PREPARARE A TUTTA LUNGHEZZA
	4.6	PREPARARE 2/3 LUNGHEZZA (6/8mm a tutta lunghezza)
6.00	2.0	PREPARARE A TUTTA LUNGHEZZA
	2.8	PREPARARE A TUTTA LUNGHEZZA
	3.2	PREPARARE A TUTTA LUNGHEZZA
	3.6	PREPARARE A TUTTA LUNGHEZZA
	4.2	PREPARARE A TUTTA LUNGHEZZA
	4.6	PREPARARE A TUTTA LUNGHEZZA
	5.2	PREPARARE A TUTTA LUNGHEZZA
	5.6	PREPARARE A TUTTA LUNGHEZZA

Lunghezza fresa 8-18 mm

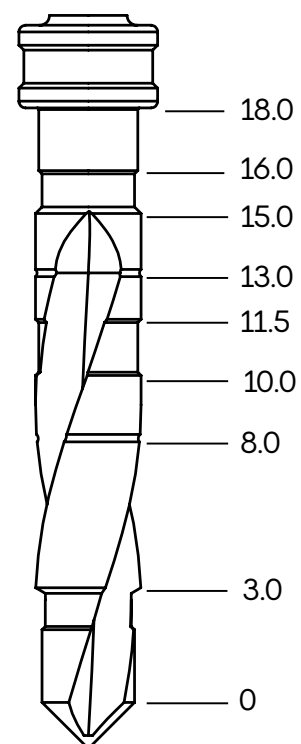

⚠ ATTENZIONE

Tutte le misure sono rappresentate in mm.

Nella preparazione del sito implantare considerare che la fresa è 1 mm più lunga della misura dell'impianto.

Vite tappo e Viti di guarigione

Torque raccomandato 15(Ncm)

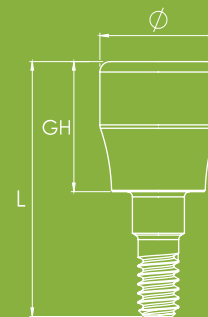



		L	Ø	Art. n°
	Vite Tappo	5.2	2.9	UF0073

		L	GH	Ø	Art. n°
	UniFit Vite di Guarigione Conica Slim	6.8	2.0	3.5	UF0095
		7.8	3.0	3.5	UF0096
		8.8	4.0	3.5	UF0097
		9.8	5.0	3.5	UF0098
		10.8	6.0	3.5	UF0099

		L	GH	Ø	Art. n°
	UniFit Vite di Guarigione Conica Regular	6.8	2.0	4.5	UF0090
		7.8	3.0	4.5	UF0091
		8.8	4.0	4.5	UF0092
		9.8	5.0	4.5	UF0093

		L	GH	Ø	Art. n°
	UniFit Vite di Guarigione Conica Wide	6.8	2.0	5.5	UF0095W
		7.8	3.0	5.5	UF0096W
		8.8	4.0	5.5	UF0097W
		9.8	5.0	5.5	UF0098W
		10.8	6.0	5.5	UF0099W

		L	GH	Ø	Art. n°
	UniFit Vite di Guarigione Slim	6.8	2.0	3.5	UF0046
		7.8	3.0	3.5	UF0047
		8.8	4.0	3.5	UF0048
		9.8	5.0	3.5	UF0049
		10.8	6.0	3.5	UF0050

		L	GH	Ø	Art. n°
	UniFit Vite di Guarigione Regular	6.8	2.0	4.5	UF0022
		7.8	3.0	4.5	UF0023
		8.8	4.0	4.5	UF0024
		9.8	5.0	4.5	UF0025
		10.8	6.0	4.5	UF0026

		L	GH	Ø	Art. n°
	UniFit Vite di Guarigione Wide	6.8	2.0	5.5	UF0046W
		7.8	3.0	5.5	UF0047W
		8.8	4.0	5.5	UF0048W
		9.8	5.0	5.5	UF0049W
		10.8	6.0	5.5	UF0050W







Kit Chirurgico





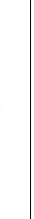

Composizione UF-NP





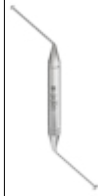







immagine a solo scopo illustrativo

Composizione UF-NP

FRESE TWIST STEP 8-18mmL							
Fresa Pilota 2mmD	2.3/ 2.8mmD	2.8/ 3.2mmD	3.2/ 3.6mmD	3.8/ 4.2mmD	4.2/ 4.6mmD	4.8/ 5.2mmD	5.2/ 5.6mmD
							
DL1820	DL1828	DL1832	DL1836	DL1842	DL1846	DL1852	DL1856
1	1	1	1	1	1	1	1

FRESE E ACCESSORI CHIRURGICI						
Fresa di Marcatura	Prolunga per Fresa	Sonda di profondità	Pin di Parallelismo 16	Pin di Parallelismo 11	Cricchetto Dinamometrico 15-35Ncm	Adattatore Driver per Cricchetto
						
RS8032	RS9027	RS6180	RS6155	RS6150	RS6112	RA0050
1	1	1	2	1	1	1

DRIVER IMPLANTARI					DRIVER PROTESICI					
NP 2mm Adattatore Esagonale Contrangolo - Medium	Driver per Cricchetto Star - Short	Driver per Cricchetto Star - Long	Adattatore manuale Star - Medium	Adattatore manuale Star - Long	TMA Driver Esagonale Contrangolo - Long	Driver Contrangolo Star - Short	Driver per Cricchetto Star - Long	Driver Manuale Star - Short	Driver Manuale Star - Long	Estrattore
										
NP0074	UF0067	UF0066	UF0071	UF0074	RS6196	RP0065	RP0005	RP0064	RP0004	UF3401
1	1	1	1	1	1	1	1	1	1	1

Frese



Frese Tri-Step

L	Ø	Misura	Codice Art.
	1.8-3.2	short	TD1511
	1.8-3.2	long	TD2218

Frese Twist Step

L	Ø	Colore	Codice Art.
<p>short</p> <p>6-13mm</p>	2.0	white	DL1320
	1.8-2.5	purple	DL1325
	2.3-2.8	red	DL1328
	2.8-3.2	blue	DL1332
	3.2-3.6	green	DL1336
	3.8-4.2	black	DL1342
	4.2-4.6	yellow	DL1346
	4.8-5.2	brown	DL1352
	5.2-5.6	grey	DL1356
<p>long</p> <p>8-18mm</p>	1.8-2.5	purple	DL1825

Strumentario Chirurgico e Protesico supplementare

		Art. n°
	Cricchetto Chirurgico Dinamometrico 35-100 Ncm	RS6111
	Cricchetto	RS6100
	Cacciavite Chirurgico	RS7001

Star

Per TMA angolato/Vite protesica TMA	L	Art. n°
 Driver per Contrangolo Star - Short	25.0	RP0018

Per TMA angolato/Vite protesica TMA	L	Art. n°
 Driver per Contrangolo Star - Long	30.0	RP0019

	L	Art. n°
 UniFit Star Handpiece Adapter - Short	25.0	UF0068

Driver TMA

Per TMA dritto		L	Art. n°
	TMA Driver Esagonale per Cricchetto - Short	20.0	RS6197

Per TMA dritto		L	Art. n°
	TMA Driver Esagonale Manuale - Short	22.4	RS6193

Per TMA dritto		L	Art. n°
	TMA Driver Esagonale Manuale Long	28.4	RS6191

Per TMA dritto		L	Art. n°
	Adattatore Esagonale per Contrangolo - Short	20.0	RS6194

Per TMA dritto		L	Art. n°
	Adattatore Esagonale per Contrangolo - Long	25.0	RS6195A





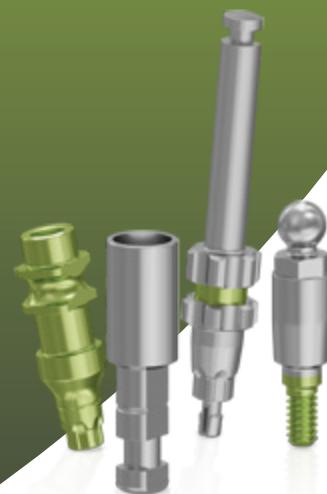

Presca d'impronta



Le componenti per la presa d'impronta sono compatibili con tutti i tipi di restauri e sono adatte sia per le procedure analogiche che digitali, sia a livello implantare che a livello dell'abutment.

L'ampia gamma di soluzioni protesiche consente una pianificazione semplice ma al tempo stesso accurata, dal dente singolo al full-arch.



Transfer | Torque raccomandato 15(Ncm)

		L	D1	Art. n°			L	D1	Art. n°
	UniFit Transfer a Cucchiaino Aperto 4.4mmDx10mmL	14.7	5.0	UF5510		UniFit Transfer a Cucchiaino Chiuso Slim 3.4mmDx9mmL	11.7	3.4	UF5109
	UniFit Transfer a Cucchiaino Aperto 4.4mmDx14mmL	18.7	5.0	UF5514		UniFit Transfer a Cucchiaino Chiuso Slim 3.4mmDx13mmL	15.7	3.4	UF5113
	UniFit Transfer a Cucchiaino Aperto Slim 3.4mmDx10mmL	14.7	4.8	UF5610		UniFit Transfer a Cucchiaino Chiuso 4.4mmDx9mmL	11.7	4.4	UF5209
	UniFit Transfer a Cucchiaino Aperto Slim 3.4mmDx14mmL	18.7	4.8	UF5614		UniFit Transfer a Cucchiaino Chiuso 4.4mmDx13mmL	15.7	4.4	UF5213
	UniFit Transfer a Cucchiaino Aperto Wide 5.4mmDx10mmL	14.7	6	UF5510W		UniFit Transfer a Cucchiaino Chiuso Wide 5.4mmDx9mmL	11.7	5.4	UF5209W
	UniFit Transfer a Cucchiaino Aperto Wide 5.4mmDx14mmL	18.7	6	UF5514W		UniFit Transfer a Cucchiaino Chiuso Wide 5.4mmDx13mmL	15.7	5.4	UF5213W

Viti Transfer		L	D1	Art. n°
	UniFit Vite Transfer a Cucchiaino Aperto Short	24	3.1	UF5010
	UniFit Vite Transfer a Cucchiaino Aperto Long	28	3.1	UF5014
	UniFit Vite Transfer a Cucchiaino Chiuso Short	16	2.8	UF5126
	UniFit Vite Transfer a Cucchiaino Chiuso Long	20	2.8	UF5127

Analogo

		L	D1	Art. n°
	UniFit Analogo Impianto	12.6	3.6	UF0007

Protesi cementata

Torque raccomandato 35(Ncm)

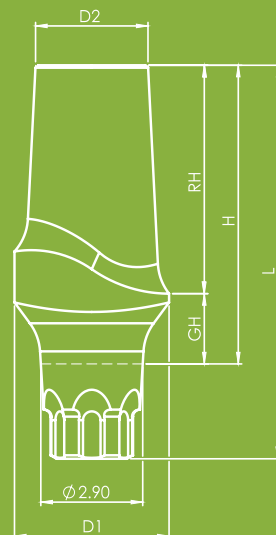



		L	D1	D2	H	GH	RH	Art. n°
	UniFit Abutment Provisorio Anti-Rotazionale Slim 3.5mmD	14.2	3.5	3.4	11.5	2	9.5	UF0036
	UniFit Abutment Provisorio Rotazionale Slim 3.5mmD	13.8	3.5	3.4	11.5	2	9.5	UF0037
	UniFit Abutment Provisorio Anti-Rotazionale 4.5mmD	14.2	4.5	3.4	11.5	2	9.5	UF0043
	UniFit Abutment Provisorio Rotazionale 4.5mmD	14.2	5.5	3.4	11.5	2	9.5	UF0044
	UniFit Abutment Provisorio Anti-Rotazionale Wide 5.5mmD	13.8	4.5	3.4	11.5	2	9.5	UF0043W
	UniFit Abutment Provisorio Rotazionale Wide 5.5mmD	13.8	5.5	3.4	11.5	2	9.5	UF0044W
	UniFit Abutment Dritto	12.2	4.4	3.2	9.5	3.0	6.5	UF0010
		11.2	4.4	3.2	8.5	2.0	6.5	UF0011
		10.2	4.4	3.2	7.5	1.0	6.5	UF0012
	UniFit Abutment Dritto Wide	12.2	5.1	3.2	9.5	3.0	6.5	UF0010W
		11.2	5.1	3.2	8.5	2.0	6.5	UF0011W
		10.2	5.1	3.2	7.5	1.0	6.5	UF0012W

		L	D1	D2	H	GH	RH	Art. n°
	UniFit Abutment Dritto Long	16.2	4.4	2.9	13.5	1.0	12.5	UF1251
		17.2	4.4	2.9	14.5	2.0	12.5	UF1252
		18.2	4.4	2.9	15.5	3.0	12.5	UF1253
	UniFit Abutment Dritto Long Wide	16.2	5.1	2.9	13.5	1.0	12.5	UF1251W
		17.2	5.1	2.9	14.5	2.0	12.5	UF1252W
		18.2	5.1	2.9	15.5	3.0	12.5	UF1253W
	UniFit Abutment Dritto Slim Senza Spalla	11.0	4.0	3.0	8.3	2.3	6.0	UF0020
	UniFit Abutment Angolato 15°	10.2	4.4	2.3	7.5	1.0	6.5	UF0013
		11.2	4.4	2.3	8.5	2.0	6.5	UF0014
		12.2	4.4	2.3	9.5	3.0	6.5	UF0015
	UniFit Abutment Angolato Wide 15°	10.2	5.1	2.3	7.5	1	6.5	UF0013W
		11.2	5.1	2.3	8.5	2	6.5	UF0014W
		12.2	5.1	2.3	9.5	3	6.5	UF0015W
	UniFit Abutment Angolato 25°	10.7	4.4	2.9	8.0	1.5	6.5	UF2515
		12.2	4.4	2.9	9.5	3.0	6.5	UF2530
	UniFit Abutment Angolato 35°	10.7	4.4	2.8	8.0	1.5	6.5	UF3515
		12.2	4.4	2.8	9.5	3.0	6.5	UF3530

Protesi Avvitata Abutment Calcinabili

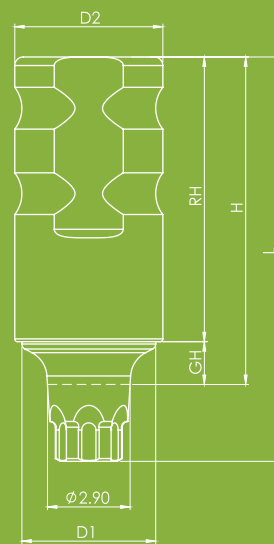
Torque raccomandato 35(Ncm)



Abutment Calcinabili		L	D1	D2	H	GH	RH	Art. n°
	UniFit Abutment Cromo Cobalto/Plastica Anti-Rotazionale	13.7	3.9	3.9	11	1	10	UF3094
	UniFit Abutment Cromo Cobalto/Plastica Rotazionale	13.3	3.9	3.9	11	1	10	UF3100

Viti		L	D1	Art. n°
	UniFit Vite Abutment M1.6	7.2	2.2	UF0001

CAD CAM

I componenti CAD - CAM e le librerie digitali consentono al Clinico e al Tecnico di creare manufatti protesici di alto livello su impianti Adin, secondo i più attuali protocolli di workflow digitale.

L'ampia gamma di componenti disponibili risponde a qualsiasi esigenza protesica, dal dente singolo a casi di edentulia parziale o totale.



Scan Body per impianto

Scan body | Per Scanner Intra-orale e da laboratorio

		H	Art. n°
	UniFit Scan Body	7	UF0088

		H	Art. n°
	UniFit Scan Body	10	UF0089

Analogo Digitale



		L	D1	Art. n°
	UniFit Analogo impianto	10.0	3.6	UF0007

		Art. n°
	Vite di Ritenzione	RS1002

Avvitare con Driver da 1.27 mm

Ti Base Abutment

Torque raccomandato 35(Ncm)

		L	RH	GH	D1	D2	W	Art. n°			L	RH	GH	D1	D2	W	Art. n°
 <p>Ti Base UniFit Abutment, Anti-Rotazionale</p>		7.7	4	1	4.5	3.2	0.5	TB07411	 <p>Ti Base UniFit Abutment, Anti-Rotazionale Wide</p>		7.7	4	1	5.5	3.2	1	TB07411W
		9.7	6	1	4.5	3.1	0.5	TB07611			9.7	6	1	5.5	3.1	1	TB07611W
		11.7	8	1	4.5	2.9	0.5	TB07811			11.7	8	1	5.5	2.9	1	TB07811W
		8.7	4	2	4.5	3.2	0.5	TB07421			8.7	4	2	5.5	3.2	1	TB07421W
		10.7	6	2	4.5	3.1	0.5	TB07621			10.7	6	2	5.5	3.1	1	TB07621W
		12.7	8	2	4.5	2.9	0.5	TB07821			12.7	8	2	5.5	2.9	1	TB07821W
		9.7	4	3	4.5	3.2	0.5	TB07431			9.7	4	3	5.5	3.2	1	TB07431W
		11.7	6	3	4.5	3.1	0.5	TB07631			11.7	6	3	5.5	3.1	1	TB07631W
		13.7	8	3	4.5	2.9	0.5	TB07831			13.7	8	3	5.5	2.9	1	TB07831W
		10.7	4	4	4.5	3.2	0.5	TB07441			10.7	4	4	5.5	3.2	1	TB07441W
		12.7	6	4	4.5	3.1	0.5	TB07641			12.7	6	4	5.5	3.1	1	TB07641W
		14.7	8	4	4.5	2.9	0.5	TB07841			14.7	8	4	5.5	2.9	1	TB07841W

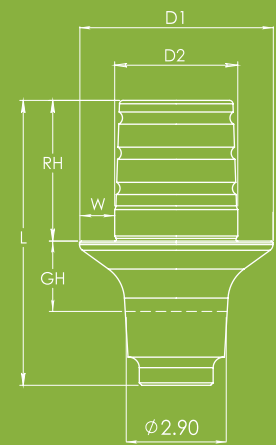

	L	RH	GH	D1	D2	W	Art. n°
 Ti Base UniFit Abutment, Rotazion.	7.0	4	1	4.5	3.2	0.5	TB07412
	9.0	6	1	4.5	3.1	0.5	TB07612
	11.0	8	1	4.5	2.9	0.5	TB07812
	8.0	4	2	4.5	3.2	0.5	TB07422
	10.0	6	2	4.5	3.1	0.5	TB07622
	12.0	8	2	4.5	2.9	0.5	TB07822
	9.0	4	3	4.5	3.2	0.5	TB07432
	11.0	6	3	4.5	3.1	0.5	TB07632
	13.0	8	3	4.5	2.9	0.5	TB07832
	10.0	4	4	4.5	3.2	0.5	TB07442
	12.0	6	4	4.5	3.1	0.5	TB07642
	14.0	8	4	4.5	2.9	0.5	TB07842

	L	RH	GH	D1	D2	W	Art. n°
 Ti Base UniFit Abutment, Rotazion. Wide	7.0	4	1	5.5	3.2	1	TB07412W
	9.0	6	1	5.5	3.1	1	TB07612W
	11.0	8	1	5.5	2.9	1	TB07812W
	8.0	4	2	5.5	3.2	1	TB07422W
	10.0	6	2	5.5	3.1	1	TB07622W
	12.0	8	2	5.5	2.9	1	TB07822W
	9.0	4	3	5.5	3.2	1	TB07432W
	11.0	6	3	5.5	3.1	1	TB07632W
	13.0	8	3	5.5	2.9	1	TB07832W
	10.0	4	4	5.5	3.2	1	TB07442W
	12.0	6	4	5.5	3.1	1	TB07642W
	14.0	8	4	5.5	2.9	1	TB07842W

Ti Base Abutment

Torque raccomandato 35(Ncm)

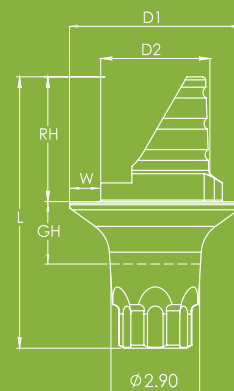

Ti Base UniFit Abutment, Angolato

L	RH	GH	D1	D2	W	Art. n°
7.7	4	1	4.5	3.2	0.5	TB07413
9.7	6	1	4.5	3.1	0.5	TB07613
11.7	8	1	4.5	2.9	0.5	TB07813
8.7	4	2	4.5	3.2	0.5	TB07423
10.7	6	2	4.5	3.1	0.5	TB07623
12.7	8	2	4.5	2.9	0.5	TB07823
9.7	4	3	4.5	3.2	0.5	TB07433
11.7	6	3	4.5	3.1	0.5	TB07633
13.7	8	3	4.5	2.9	0.5	TB07833



Ti Base UniFit Abutment, Angolato Wide

L	RH	GH	D1	D2	W	Art. n°
7.7	4	1	5.5	3.2	1	TB07413W
9.7	6	1	5.5	3.1	1	TB07613W
11.7	8	1	5.5	2.9	1	TB07813W
8.7	4	2	5.5	3.2	1	TB07423W
10.7	6	2	5.5	3.1	1	TB07623W
12.7	8	2	5.5	2.9	1	TB07823W
9.7	4	3	5.5	3.2	1	TB07433W
11.7	6	3	5.5	3.1	1	TB07633W
13.7	8	3	5.5	2.9	1	TB07833W

Driver ASC

			D1	D2	L	L2
	RP6401	Driver manuale per vite foro angolato Star - Short 23.4 L	9.4	1.4	23.4	9.0
	RP6402	Driver manuale per vite foro angolato Star - Long 28.4 L	9.4	1.4	28.4	14.0
	RP6403	Driver da cricchetto per vite foro angolato Star - Short 17.0 L	7.0	1.4	17.0	11.0
	RP6404	Driver da cricchetto per vite foro angolato Star - Long 22.0 L	7.0	1.4	22.0	16.0
	RP6405	Driver da contrangolo per vite foro angolato Star - Extra Short 20.0 L	2.35	1.4	20.0	7.0
	RP6406	Driver da contrangolo per vite foro angolato Star - Short 25.0 L	2.35	1.4	25.0	12.0
	RP6407	Driver da contrangolo per vite foro angolato Star - Long 30.0 L	2.35	1.4	30.0	17.0

C-Type Ti Base Abutment

Torque raccomandato 35(Ncm)

Per ulteriori informazioni su prodotto e utilizzo fare riferimento alle IFU028

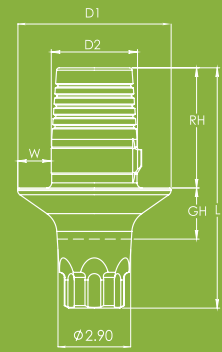

		L	RH	GH	D1	D2	W	Art. n°
	C-Type Ti Base UniFit Abutment, Anti-Rotazionale	8.4	4.7	1	4.3	3.36	0.5	TB07414
		9.4	4.7	2	4.3	3.36	0.5	TB07424
		10.4	4.7	3	4.3	3.36	0.5	TB07434
		11.4	4.7	4	4.3	3.36	0.5	TB07444

Vite Abutment per Scan Body, Ti Base

		L	D1	Art. n°
	UniFit Vite Abutment M1.6	7.2	2.2	UF0001

TMA™ - Multi Unit

Torque raccomandato 35 (Ncm)

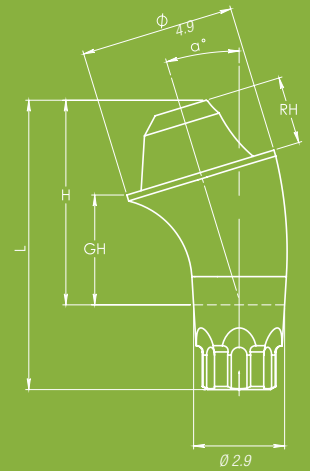

Il Sistema TMA™ per la linea UniFit include abutment dritti e angolati (17°, 30°, 45°), con ingaggio ad esagono interno in diverse altezze e indice esagonale. Ogni abutment viene fornito completo di portatore che ne agevola il prelievamento e posizionamento.

TMA dritti		L	H	GH	RH	Art. n°
	UniFit Abutment Transmucoso Dritto 1mm	4.7	3.1	1.0	2.1	UF0032
	UniFit Abutment Transmucoso Dritto 2mm	5.7	4.1	2.0	2.1	UF0033
	UniFit Abutment Transmucoso Dritto 3mm	6.7	5.1	3.0	2.1	UF0034
	UniFit Abutment Transmucoso Dritto 4mm	7.7	6.1	4.0	2.1	UF3729
	UniFit Abutment Transmucoso Dritto 5mm	8.7	7.1	5.0	2.1	UF3730



Viti incluse nella confezione		L	D1	Art. n°
	UniFit Vite di Ritenzione per TMA 1mm	8	3.1	UF0039
	UniFit Vite di Ritenzione per TMA 2mm	9	3.1	UF0040
	UniFit Vite di Ritenzione per TMA 3mm	10	3.1	UF0041
	UniFit Vite di Ritenzione per TMA 4mm	11	3.1	UF3409
	UniFit Vite di Ritenzione per TMA 5mm	12	3.1	UF3412

TMA angolati		L	H	GH	RH	Art. n°
	UniFit Abutment Transmucoso Angolato 17° 2.5mm	8.3	5.6	2.5	2.2	UF3734
	UniFit Abutment Transmucoso Angolato 17° 3.5mm	9.2	6.5	3.5	2.2	UF3737
	UniFit Abutment Transmucoso Angolato 30° 3mm	9.2	6.5	3.0	2.2	UF3735
	UniFit Abutment Transmucoso Angolato 30° 4mm	10.2	7.5	4.0	2.2	UF3738
	UniFit Abutment Transmucoso Angolato 45° 4mm	10.6	7.9	4.0	2.2	UF3736

Vite UF3403 inclusa

TMA Cappetta di guarigione	L	D1	D2	Art. n°
TMA Cappetta di Guarigione (Vite RS3404 inclusa nella confezione)	5.5	4.9	3.5	RS5005
	7.0	4.9	3.5	RS5003



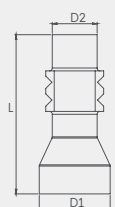

UniFit™ Viti	L	∅	Codice Art.
 Vite per TMA Angolato	7.6	1.95	UF3403
 TMA Vite Protesica 15(Ncm)	4.1	2.1	RS3404

UniFit Protesi per TMA™

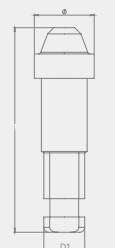

TMA Transfer		L	D1	D2	Codice Art.
	TMA Transfer per Impronta a Cucchiaino Aperto (Vite RS5008 inclusa nella confezione)	11.0	4.9	3.1	RS5006
	TMA Transfer per Impronta a Cucchiaino Chiuso (Vite RS5009 inclusa nella confezione)	8.0	4.9	4.1	RS5011



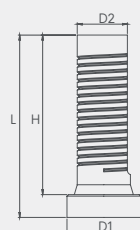

TMA Anologo		L	D1	Codice Art.
	TMA Anologo	16.8	4.9	RS5004

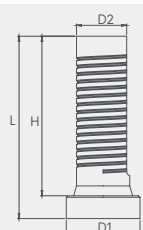

TMA Abutment Calcinabile		L	D1	D2	H	Codice Art.
	TMA Abutment Calcinabile (Vite RS3404 inclusa nella confezione)	12.0	4.9	3.3	10.5	RS5001





TMA Abutment Provvisorio		L	D1	D2	H	Codice Art.
	TMA Abutment Provvisorio in Titanio (Vite RS3404 inclusa nella confezione)	12.0	4.9	3.5	10.5	RS4900

TMA Viti		L	∅	Codice Art.
	TMA Vite per Transfer a Cucchiaino Aperto	14	2.1	RS5008
	TMA Vite per Transfer a Cucchiaino Chiuso	6.8	2.5	RS5009

UniFit Protesi Digitale per TMA™

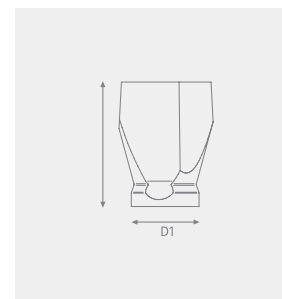
TMA Scan Body		L	D1	Codice Art.
	TMA Scan Body (Vite TM0001 inclusa nella confezione)	6.0	4.9	TM0006
		9.0	4.9	TM0009



TMA Analogo Modello Digitale		L	D1	D2	Codice Art.
	TMA Analogo Modello Digitale	12.0	4.9	3.35	RS1001

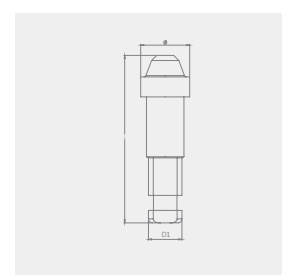

Utilizzare con driver protesico esagonale da 1.27.

TMA Abutment da incollaggio		L	D1	D2	H	W	Codice Art.
	TMA Abutment da incollaggio	4.9	4.9	3.9	3.4	0.5	TM0010
	TMA Abutment da incollaggio, low profile	4.9	5.5	4.5	4.4	0.5	TM0011

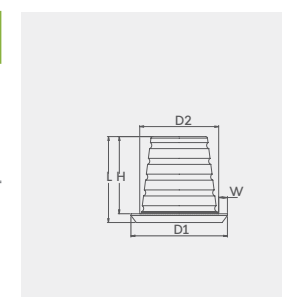

Vite TM0001 inclusa nella confezione

TMA Abutment Provvisorio		L	D1	D2	H	Codice Art.
	TMA Abutment Provvisorio in Titanio (Vite RS3404 inclusa nella confezione)	12.0	4.9	3.5	10.5	RS4900

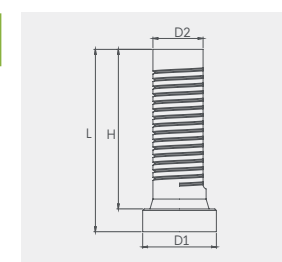

TMA Viti		Codice Art.
	TMA Vite Scan Body	TM0001

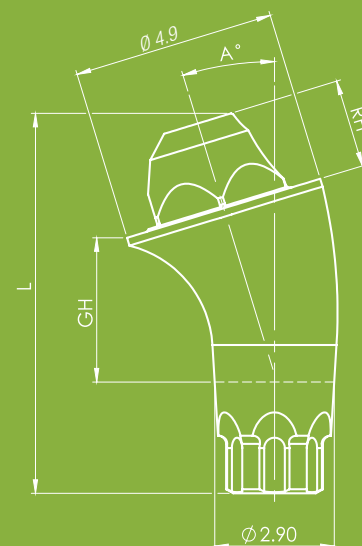

Single TMA™

Torque raccomandato 35(Ncm)



Il sistema STMA (Single Trans Mucosal Abutment) utilizza tutti i vantaggi della linea TMA MultiUnit, consentendo al contempo la precisione e la flessibilità della protesi avvitata su singolo elemento. Il sistema contempla la possibilità di restauri protesici full digital, offrendo una linea di soluzioni esclusive, moderne e complete tale da garantire al professionista la scelta più adeguata per l'ottenimento del miglior risultato estetico.

UniFit STMA Dritti		L	H	GH	RH	Art. n°
	UniFit Single TMA Dritto 1mm	4.7	3.1	1.0	2.1	UF0032S
	UniFit Single TMA Dritto 2mm	5.7	4.1	2.0	2.1	UF0033S
	UniFit Single TMA Dritto 3mm	6.7	5.1	3.0	2.1	UF0034S
	UniFit Single TMA Dritto 4mm	7.7	6.1	4.0	2.1	UF3729S
	UniFit Single TMA Dritto 5mm	8.7	7.1	5.0	2.1	UF3730S

Viti incluse nella confezione		L	D1	Art. n°
	UniFit Vite di Ritenzione per TMA 1mm	8	3.1	UF0039
	UniFit Vite di Ritenzione per TMA 2mm	9	3.1	UF0040
	UniFit Vite di Ritenzione per TMA 3mm	10	3.1	UF0041
	UniFit Vite di Ritenzione per TMA 4mm	11	3.1	UF3409
	UniFit Vite di Ritenzione per TMA 5mm	12	3.1	UF3412





UniFit STMA Angolati		L	H	GH	RH	Art. n°
	UniFit Single TMA Angolato 17° 2.5mm	8.2	5.6	2.5	2.2	UF3734S
	UniFit Single TMA Angolato 17° 3.5mm	9.3	6.5	3.5	2.2	UF3737S
	UniFit Single TMA Angolato 30° 3mm	9.2	6.5	3.0	2.2	UF3735S
	UniFit Single TMA Angolato 30° 4mm	10.3	7.5	4.0	2.2	UF3738S

Vite UF3403 inclusa

STMA Cappetta di guarigione	L	D1	D2	Art. n°
TMA Cappetta di Guarigione (Vite RS3404 inclusa nella confezione)	5.5	4.9	3.5	RS5005S



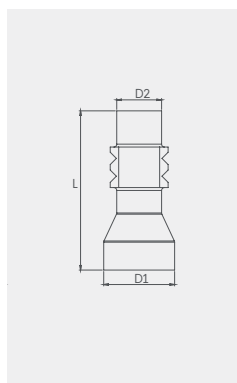

UniFit™ Viti	L	∅	Codice Art.
 Vite per TMA Angolato	7.6	1.95	UF3403
 TMA Vite Protesica 15(Ncm)	4.1	2.1	RS3404

UniFit Protesi per Single TMA™

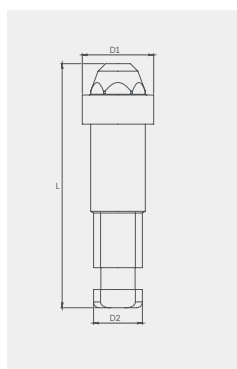

STMA Transfer		L	D1	D2	Codice Art.
	Single TMA Transfer per impronta a Cucchiaino Aperto (Vite RS5008 inclusa nella confezione)	11.0	4.9	3.1	RS5006S
	Single TMA Transfer per impronta a Cucchiaino Chiuso (Vite RS5009 inclusa nella confezione)	8.0	4.9	4.1	RS5011S



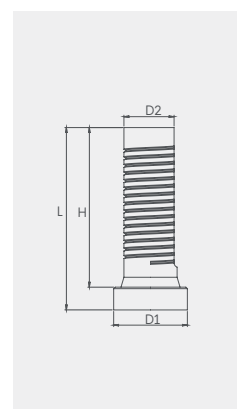

STMA Analogo		L	D1	Codice Art.
	Single TMA Analogo	16.75	4.9	RS5004S



STMA Abutment		L	D1	D2	H	Codice Art.
	Single TMA Abutment Provvisorio in Titanio (Vite RS3404 inclusa nella confezione)	12.0	4.9	3.5	10.5	RS4900S
	Single TMA Abutment Calcinabile con Vite Protesica (Vite RS3404 inclusa nella confezione)	12.0	4.9	3.5	10.35	RS5001S

UniFit Protesi Digitale per Single TMA™

STMA Scan Body		L	D1	Codice Art.	
	Single TMA Scan Body (Vite TM0001 inclusa nella confezione)	6.0	4.9	TM0006S	
		9.0	4.9	TM0009S	

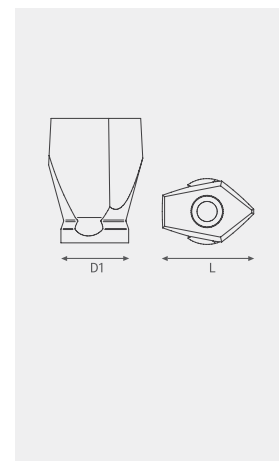

STMA Analogo Modello Digitale		L	D1	D2	Codice Art.
	Single TMA Analogo Modello Digitale	12.0	4.9	3.8	RS1001S

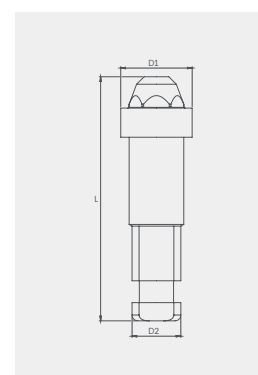

Utilizzare con driver protesico esagonale da 1.27.

STMA Abutment Provvisorio		L	D1	D2	H	Codice Art.
	Single TMA Abutment Provvisorio in Titanio (Vite RS3404 inclusa nella confezione)	12.0	4.9	3.5	10.5	RS4900S

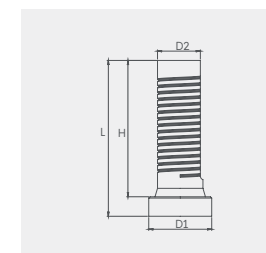

STMA Abutment da incollaggio		L	D1	D2	H	W	Codice Art.
	Single TMA Abutment da incollaggio, low profile (Vite TM0001 inclusa nella confezione)	4.9	5.5	4.5	4.4	0.5	TM0011S

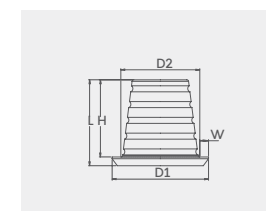

Protesi Overdenture

Torque raccomandato 35(Ncm)

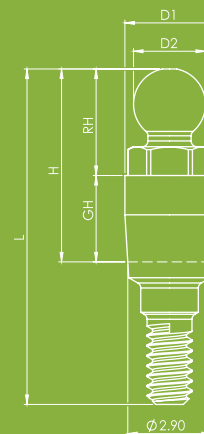

		L	Ø	D2	Art. n°
	Cappetta Bianca per Attacco a sfera (Nylon)	2.6	4.1	3.6	RS2660

		L	Ø	D2	Art. n°
	Cappetta Rosa Soft per Attacco a sfera (Nylon)	2.6	4.1	3.6	RS2662

		L	Ø	D2	Art. n°
	Cappetta in Titanio per Attacco a sfera	2.9	4.7	4.7	RS2670

		L	D1	D2	H	GH	RH	Art. n°
	UniFit Attacco a sfera 0.5mm	9.1	3.1	2.5	4.1	0.6	3.5	UF0051
	UniFit Attacco a sfera 1mm	9.5	3.1	2.5	4.5	1.0	3.5	UF0052
	UniFit Attacco a sfera 2mm	10.5	3.1	2.5	5.5	2.0	3.5	UF0053
	UniFit Attacco a sfera 3mm	11.5	3.1	2.5	6.5	3.0	3.5	UF0054
	UniFit Attacco a sfera 4mm	12.5	3.1	2.5	7.5	4.0	3.5	UF0055
	UniFit Attacco a sfera 5mm	13.5	3.1	2.5	8.5	5.0	3.5	UF0056

		L	Ø	Art. n°
	Analogo Attacco a sfera	16.6	4.0	RS5740

		Art. n°
	Torque Driver per Attacco a sfera	RS6090

Chirurgia Guidata

Adinguide™ è stato creato per offrire al professionista la possibilità di espandere l'attività della propria clinica e dare una risposta alle esigenze contemporanee.

I kit di chirurgia guidata Adin sono stati progettati per mettere in pratica procedure semplici e precise, al fine di garantire un posizionamento dell'impianto in totale sicurezza.

L'innovativa tecnologia di irrigazione "ActiveFlow" migliora il raffreddamento del sito implantare in presenza di una dima chirurgica.

Le frese Adinguide sono progettate con canali intagliati che permettono alla soluzione fisiologica di defluire attraverso la boccola per garantire una migliore irrigazione e ridurre il surriscaldamento osseo.

Il nostro kit di frese, dal design esclusivo, è intuitivo e facile da usare in base al diametro e alla lunghezza dell'impianto.

Il mucotomo consente un facile accesso senza lembo e la fresa pilota regolarizza le creste frastagliate.

Frese auto-centranti – gli stop, di diametro 5.5 mm e 3.3 mm, presenti sulla parte alta delle frese, ingaggiano la boccola prima ancora che l'apice possa toccare l'osso.

Questo sistema garantisce un posizionamento corretto della fresa, oltre che una precisa e accurata osteotomia alla profondità desiderata.



Kit Chirurgia Guidata

Frese | GSK001



Procedura guidata completa:



Connessione
Conica 7°



GS Kit
Strumentario
GSK005

5.5mmD Boccola
GS0055



GS5055 Mucotomo 5.0mmD, S-5.5



GS0825 Fresa S-5.5, 2.5/1.8mmDx8.0mmL



GS1325 Fresa S-5.5, 2.5/1.8mmDx13.0mmL



GS0625 Fresa Pilota S-5.5, 2.5/1.8mmDx6.0mmL



GS1025 Fresa S-5.5, 2.5/1.8mmDx10.0mmL



GS1625 Fresa S-5.5, 2.5/1.8mmDx16.0mmL



GS1125 Fresa S-5.5, 2.5/1.8mmDx11.5mmL

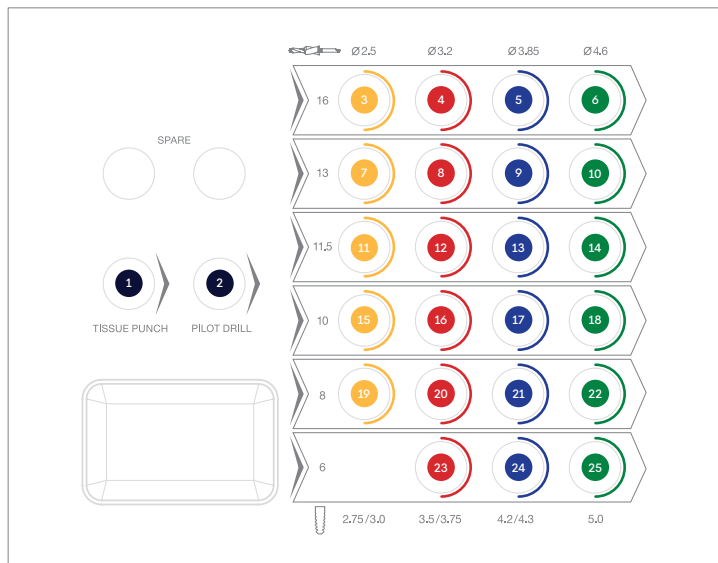

GS0632 Fresa S-5.5, 3.2/2.5mmDx6.25mmL



GS0638 Fresa S-5.5, 3.85/3.2mmDx6.25mmL



GS0646 Fresa S-5.5, 4.6/3.85mmDx6.25mmL



GS0832 Fresa S-5.5, 3.2/2.5mmDx8.0mmL



GS0838 Fresa S-5.5, 3.85/3.2mmDx8.0mmL



GS0846 Fresa S-5.5, 4.6/3.85mmDx8.0mmL



GS1032 Fresa S-5.5, 3.2/2.5mmDx10.0mmL



GS1038 Fresa S-5.5, 3.85/3.2mmDx10.0mmL



GS1046 Fresa S-5.5, 4.6/3.85mmDx10.0mmL



GS1132 Fresa S-5.5, 3.2/2.5mmDx11.5mmL



GS1138 Fresa S-5.5, 3.85/3.2mmDx11.5mmL



GS1146 Fresa S-5.5, 4.6/3.85mmDx11.5mmL



GS1332 Fresa S-5.5, 3.2/2.5mmDx13.0mmL



GS1338 Fresa S-5.5, 3.85/3.2mmDx13.0mmL



GS1346 Fresa S-5.5, 4.6/3.85mmDx13.0mmL



GS1632 Fresa S-5.5, 3.2/2.5mmDx16.0mmL



GS1638 Fresa S-5.5, 3.85/3.2mmDx16.0mmL



GS1646 Fresa S-5.5, 4.6/3.85mmDx16.0mmL

Kit Chirurgia Guidata Strumentario | GSK005



Procedura guidata completa:



Connessione
conometrica 7°



GS Kit Frese
GSK001



5.5mmD Boccia
GS0055

1

GS1915



Fresa per vite di ancoraggio S-2.0, 2.0/1.5mmDx19mmL

2

GS1917



Fresa per vite di ancoraggio S-2.0, 2.0/1.7mmDx19mmL

3

GS0028



Driver da contrangolo per vite di ancoraggio

4

GS5041



Guided UniFit Handpiece Fixture Mount S-5.5

5

GS5043



Guided UniFit Ratchet Fixture Mount S-5.5

6

GS5037



Guided UniFit Ratchet Fixture Mount S-5.5, Screw Retained (qty.4)

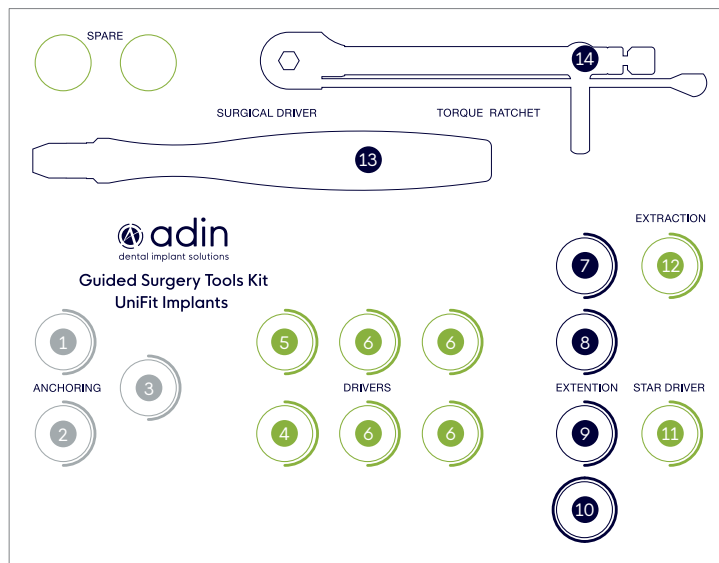

7

GS0023



Prolunga da cricchetto L10.5

9

GS0021



Prolunga da contrangolo per mount L10.5

11

RP0004



Driver Manuale Star - Long

8

GS0024



Prolunga da cricchetto L14.5

10

RS9027



Handpiece Socket L14.5

12

GS5046



UniFit Driver di recupero da cricchetto

13

GS0027



Cacciavite Chirurgico per Guidata

14

GS6111







Cricchetto Chirurgico Dinamometrico 35-100 Ncm per esagono 4mm

Prodotti aggiuntivi Venduti separatamente

Accessori

			Art. n°
	Pin crestale S-3.3	x 3	GS0006
	Pin crestale S-5.5	x 3	GS0007
	2.0mmD Boccola ancoraggio	x 3	GS1920
	5.5mmD Boccola	x 1	GS0055
	2.0mm Boccola per vite di ancoraggio	x 3	GS0020

Frese 18mm

		Art. n°			Art. n°			Art. n°
	Fresa S-5.5, 2.5/1.8mm Dx18.0mmL	GS1825		Fresa S-5.5, 3.2/2.5mmD x18.0mmL	GS1832		Fresa S-5.5, 3.85/3.2mmD x18.0mmL	GS1838
	Fresa S-5.5, 4.6/3.85mmD x18.0mmL	GS1846						

One™

Hex: 2.4mm



La linea implantare One™ rappresenta una soluzione “Monoblock” per una riabilitazione conveniente e immediata. Il design all'avanguardia consente di eliminare il rischio di colonizzazione batterica tra impianto e abutment, tra le cause del riassorbimento gengivale.

Gli impianti One™ con diametro narrow sono inoltre ideali per un utilizzo in spazi interprossimali ridotti, come nel caso di incisivi laterali sia in mascella che in mandibola.

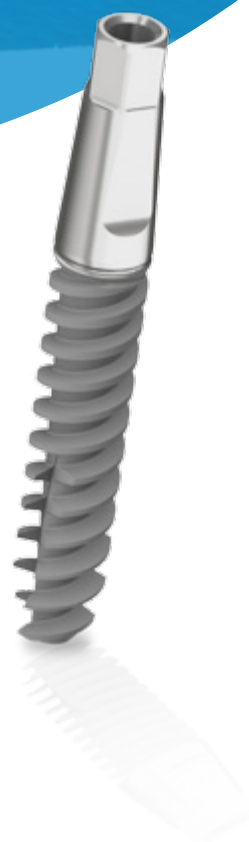

Incluso nella confezione



Driver per
Cricchetto One
Piece - Short

RS6025

Parte aggiuntiva



Driver per
Cricchetto One
Piece - Long

RS6026

Torque di inserimento raccomandato fino a 50 Ncm

	∅	L	D3	Codice Art.
	3.0	10.00	2.30	IO1030
		11.50	2.30	IO1130
		13.00	2.30	IO1330
		15.00	2.30	IO1530
	3.3	10.00	2.60	IO1033
		11.50	2.60	IO1133
		13.00	2.60	IO1333
		15.00	2.60	IO1533
	3.6	10.00	2.90	IO1036
		11.50	2.90	IO1136
		13.00	2.90	IO1336
		15.00	2.90	IO1536
	4.2	10.00	3.30	IO1042
		11.50	3.30	IO1142
		13.00	3.30	IO1342
		15.00	3.30	IO1542
	5.0	10.00	4.10	IO1050
		11.50	4.10	IO1150
		13.00	4.10	IO1350
		15.00	4.10	IO1550

Template Radiografico One™ | ASD0614

Protocollo di Foratura

Velocità di foratura raccomandata: fino a 700 rpm

Diametro
implantare

ø3.0

ø3.3

ø3.6

ø4.2

ø5.0

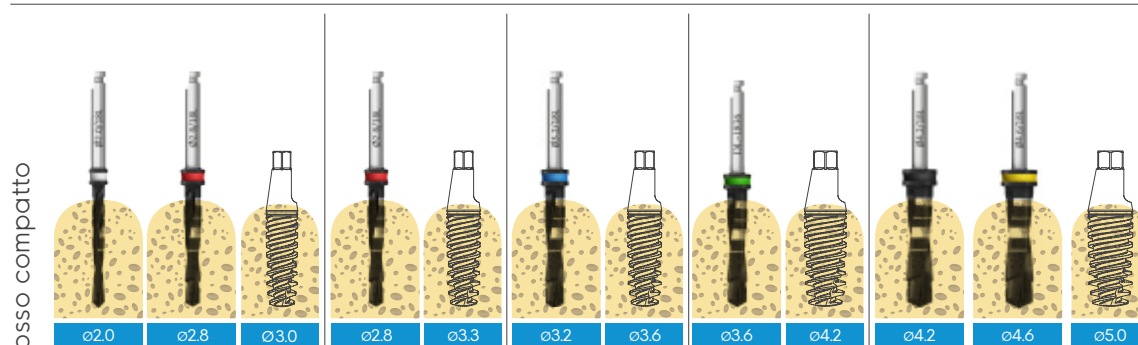

Diametro
implantare

ø3.0

ø3.3

ø3.6

ø4.2

ø5.0

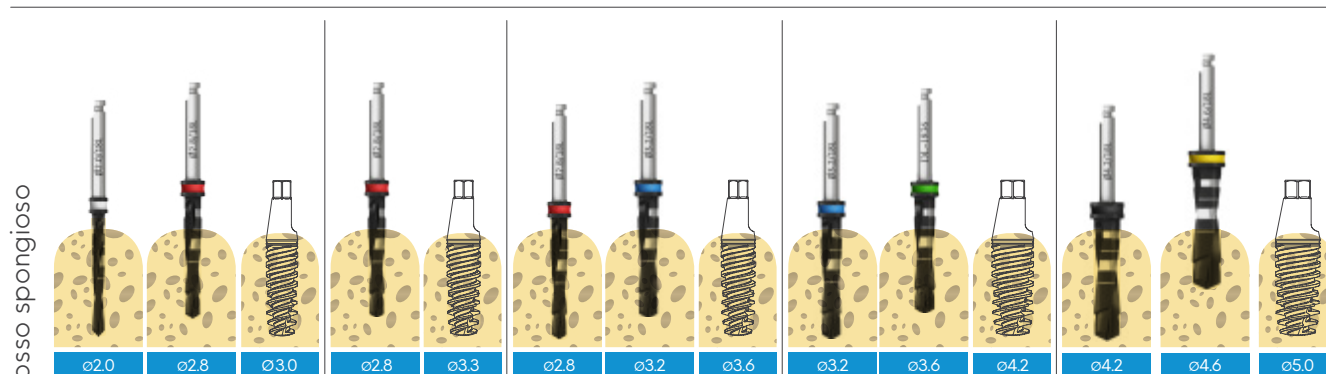

Analogo

Analogo	L	D1	Codice Art.
	20.60	3.00	RO0030
	20.60	3.30	RO0033
	20.60	3.60	RO0036
	20.60	4.25	RO0042
	20.60	5.00	RO0050

Long Implants & Zygomatic



Long Implants

Touareg OS™

CloseFit™ WP

Connessione esagono interno

Connessione conica standard

Platform Switching Integrato

Conicità inversa Platform Switching Integrato

Collare liscio 5 mm

Collare liscio 5 mm

Spire trapezoidali a disegno variabile doppio passo
2.4mm (2×1.2 mm)

Micro anelli coronali

Spire trapezoidali a disegno variabile doppio passo
2.4mm (2×1.2 mm)

Automaschiante Osteocondensante Ridirezionabile in fase di inserimento

Automaschiante Osteocondensante Ridirezionabile in fase di inserimento

Apice piatto attivo

Apice arrotondato attivo Narrow 2.5 mm

Long Implants

La linea Long Implants, caratterizzata da apice rastremato e porzione coronale liscia, completa la linea tradizionale Touareg™ e CloseFit™ WP. Realizzata esclusivamente con trattamento di superficie OsseoFix, rappresenta una soluzione elettiva nei casi in cui risulti necessario un ancoraggio bi-corticale.

Superficie OsseoFix™

Titanio grado 23 (Ti 6Al 4V ELI)

Touareg™ - OS	
Lunghezza	Ø 4.2 mm
20 mm	ISF2042
22.5 mm	ISF2242
25 mm	ISF2542

CloseFit™ WP	
Lunghezza	Ø 4.3 mm
20 mm	ISPX2043
22.5 mm	ISPX2243
25 mm	ISPX2543

Frese Extra-long

L	Ø		Descrizione	Codice Art.
<p>Extra long</p> <p>16-25mmL</p>	1.8/2.5 mmD		Fresa Pilota Extra-long	DL2525
	2.5/3.2 mmD		Fresa Twist Step Extra-long	DL2532
	3.2/3.6 mmD		Fresa Twist Step Extra-long	DL2536

Protocollo di foratura Velocità di foratura raccomandata: fino a 1200 rpm

Touareg™ -OS Long Implant

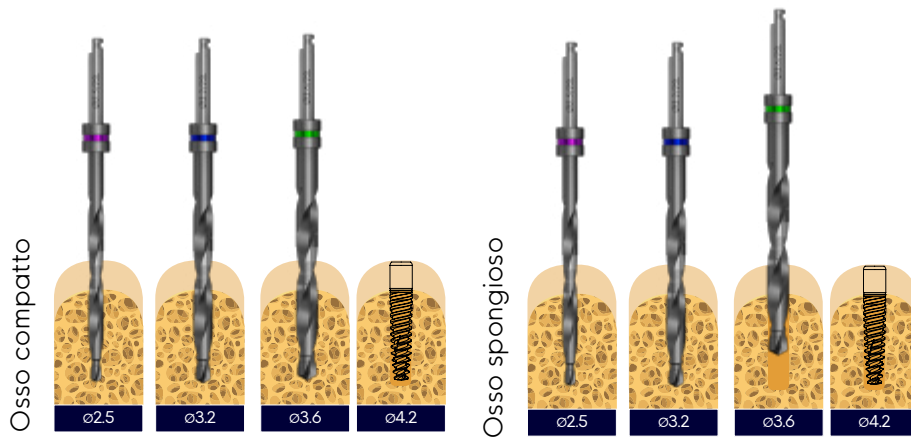

CloseFit™ WP

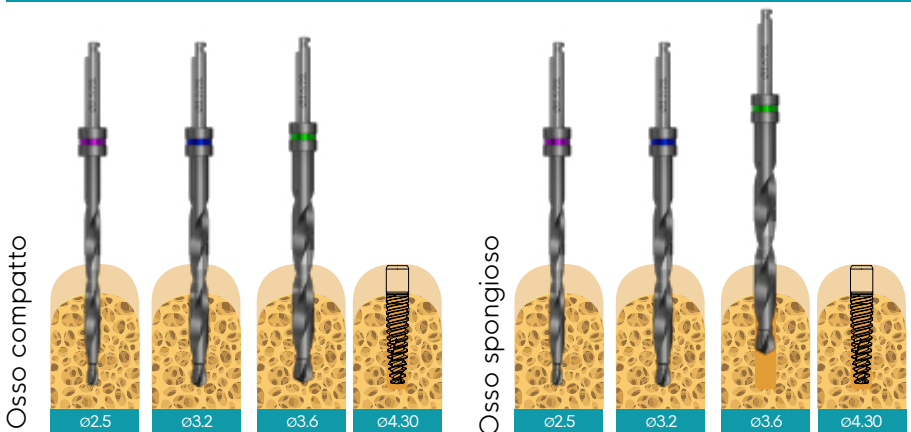

NOTE:

- Le misure sono espresse in mm.
- La fresa effettua una preparazione di 1 mm più profonda rispetto alla lunghezza dell'impianto.
- I prodotti possono essere ordinati separatamente in aggiunta al kit.
- Fresa Step con apice = 1.8mmD.

Strumentario supplementare - Touareg OS

Star (Per TMA angolato/Vite protesica TMA)



Driver per
Cricchetto Star-
Short

RP0065



Driver per
Cricchetto Star-
Long

RP0005



Driver
Manuale Star-
Long

RP0004



Driver Manuale
Star-Short

RP0064



Driver per Contrangolo
Star - Short 25.0L

RP0018



Driver per
Contrangolo
Star - Long 30.0L

RP0019

Driver TMA dritti



TMA Driver
Esagonale per
Cricchetto - Long

RS6196



TMA Driver
Esagonale per
Cricchetto - Short

RS6197



TMA
Driver Esagonale
Manuale -Long

RS6191



TMA
Driver Esagonale
Manuale-Short

RS6193



TMA
Adattatore Esagonale per
Contrangolo-Long

RS6195A



TMA
Adattatore Esagonale
per Contrangolo-Short

RS6194

TMA™ MultiUnit - Touareg OS

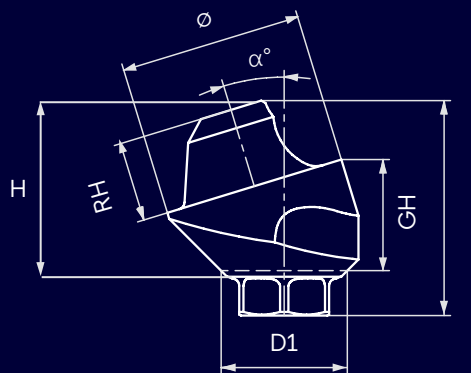

Il sistema di abutment transmucosi TMA™ è indicato per protesi avvitata multipla e può essere utilizzato in combinazione con una realizzazione protesica tradizionale.

Serve per elevare la piattaforma di appoggio della protesi laddove il restauro a livello dell'impianto non sia indicato oppure non sia realizzabile a causa della profondità o angolazione dell'impianto stesso.

Il sistema TMA™ nasce inoltre per consentire un migliore accesso protesico su impianti inclinati in arcate totalmente o parzialmente edentule ed in particolare nel caso di impianti inclinati con protesi full-arch "all-on-x".

Il Sistema TMA™ include abutment dritti e angolati (17°, 30°, 45°, 52°, 60°), con ingaggio ad esagono interno in diverse altezze e indice esagonale. Ogni abutment viene fornito completo di portatore che ne agevola il prelevamento e posizionamento.

TMA dritti		L	Ø	D1	H	GH	RH	Codice Art.
	RS Abutment Transmucoso Dritto 1mm	3.7	4.9	3.4	3.1	1	2.1	RS3731
	RS Abutment Transmucoso Dritto 2mm	4.7	4.9	3.4	4.1	2	2.1	RS3732
	RS Abutment Transmucoso Dritto 3mm	5.7	4.9	3.4	5.1	3	2.1	RS3733
	RS Abutment Transmucoso Dritto 4mm	6.7	4.9	3.4	6.1	4	2.1	RS3729
	RS Abutment Transmucoso Dritto 5mm	7.7	4.9	3.4	7.1	5	2.1	RS3730



Viti incluse nella confezione		L	Ø	Codice Art.
	RS Vite di Ritenzione per TMA 1mm	7.8	3.1	RS3406
	RS Vite di Ritenzione per TMA 2mm	8.8	3.1	RS3407
	RS Vite di Ritenzione per TMA 3mm	9.8	3.1	RS3408
	RS Vite di Ritenzione per TMA 4mm	10.8	3.1	RS3409
	RS Vite di Ritenzione per TMA 5mm	11.8	3.1	RS3412

TMA angolati		L	∅	D1	H	GH	RH	Codice Art.
	RS Abutment Transmucoso Angolato 17° 2mm	5.17	4.9	3.4	-	2	2.1	RS3734
	RS Abutment Transmucoso Angolato 17° 3mm	6.05	4.9	3.4	-	3	2.1	RS3737
	RS Abutment Transmucoso Angolato 30° 3mm	5.7	4.9	3.4	-	3	2.1	RS3735
	RS Abutment Transmucoso Angolato 30° 4mm	6.5	4.9	3.4	-	4	2.1	RS3738
	RS Abutment Transmucoso Angolato 45° 4mm	5.94	4.9	3.4	-	4	2.1	RS3736
	RS Abutment Transmucoso Angolato 52° 5mm	5.0	4.9	3.4	-	5	2.1	RS3739
	RS Abutment Transmucoso Angolato 60° 5mm	7.5	4.9	3.4	-	5	2.1	RS3740

Vite RS3403 inclusa nella confezione

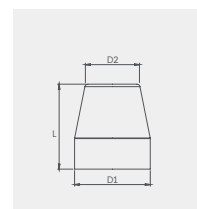
TMA Cappetta di Guarigione		L	D1	D2	Codice Art.
	TMA Cappetta di Guarigione (Vite RS3404 inclusa nella confezione)	5.5	4.9	3.5	RS5005
		7.0	4.9	3.5	RS5003







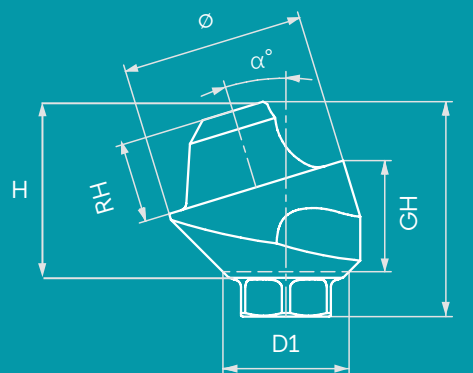

Viti		L	∅	Codice Art.
	RS Vite di Ritenzione per TMA Angolato	6.1	2.4	RS3403
	TMA Vite Protetica 15 (Ncm)	4.1	2.1	RS3404

TMA™ MultiUnit - CloseFit WP







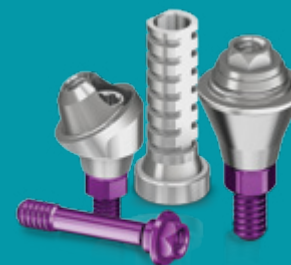

Il Sistema TMA™ per CloseFit WP include abutment dritti e angolati (17°, 30°, 52°, 60°), con ingaggio ad esagono interno in diverse altezze e indice esagonale. Ogni abutment viene fornito completo di portatore che ne agevola il prelievamento e posizionamento.

WP™ TMA dritti		L	Ø	D1	H	GH	RH	Codice Art.
	WP Abutment Transmucoso Dritto 1 mm	4.30	4.90	3.35	2.0	1.0	2.10	WP3731
	WP Abutment Transmucoso Dritto 2 mm	5.30	4.90	3.35	3.0	2.0	2.10	WP3732
	WP Abutment Transmucoso Dritto 3 mm	6.30	4.90	3.35	4.0	3.0	2.10	WP3733
	WP Abutment Transmucoso Dritto 4 mm	7.30	4.90	3.35	5.0	4.0	2.10	WP3729
	WP Abutment Transmucoso Dritto 5 mm	8.30	4.90	3.35	6.0	5.0	2.10	WP3730

Viti incluse nella confezione		L	Ø	Codice Art.
	WP Vite di Ritenzione per TMA	6.50	3.10	WP3406
	WP Vite di Ritenzione per TMA	7.50	3.10	WP3407
	WP Vite di Ritenzione per TMA	8.50	3.10	WP3408
	WP Vite di Ritenzione per TMA	9.50	3.10	WP3409
	WP Vite di Ritenzione per TMA	10.50	3.10	WP3412





WP™ TMA angolati		L	∅	D1	H	GH	RH	Codice Art.
	WP Abutment Transmucoso Angolato 17° 2.5mm	6.7	4.90	3.35	-	2.54	2.15	WP3734
	WP Abutment Transmucoso Angolato 17° 3.5mm	7.44	4.90	3.35	-	3.56	2.15	WP3737
	WP Abutment Transmucoso Angolato 30° 3mm	6.8	4.90	3.35	-	3.45	2.15	WP3735
	WP Abutment Transmucoso Angolato 30° 4mm	8.04	4.90	3.35	-	4.11	2.15	WP3738
	WP Abutment Transmucoso Angolato 52° 5mm	7.05	3.35	4.9	4.8	4.8	2.1	WP3739
	WP Abutment Transmucoso Angolato 60° 5mm	7.8	3.35	4.9	5.5	5.5	2.1	WP3740

Vite WP3403 inclusa nella confezione

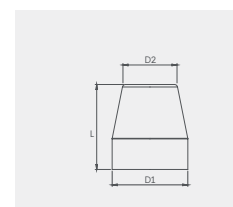

TMA Cappetta di Guarigione		L	D1	D2	Codice Art.
	TMA Cappetta di Guarigione (Vite RS3404 inclusa nella confezione)	5.5	4.9	3.5	RS5005
		7.0	4.9	3.5	RS5003



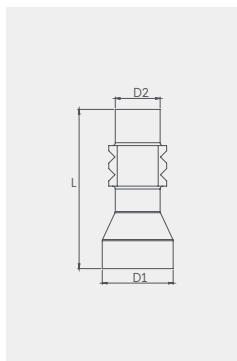

WP™ Viti		L	∅	Codice Art.
	Vite per TMA Angolato	7.1	2.35	WP3403
	TMA Vite Protesica 15(Ncm)	4.1	2.1	RS3404

Protesi per TMA™ - Touareg OS

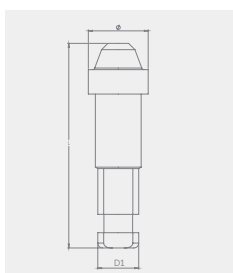

TMA Transfer		L	D1	D2	Codice Art.
	TMA Transfer per Impronta a Cucchiaino Aperto (Vite RS5008 inclusa nella confezione)	11.0	4.9	3.1	RS5006
	TMA Transfer per Impronta a Cucchiaino Chiuso (Vite RS5009 inclusa nella confezione)	8.0	4.9	4.1	RS5011



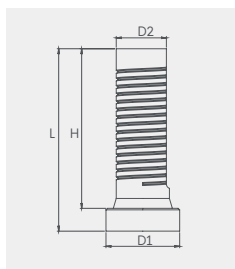

TMA Analogo		L	D1	Codice Art.
	TMA Analogo	16.8	4.9	RS5004



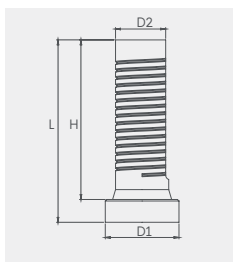

TMA Abutment Calcinabile		L	D1	D2	H	Codice Art.
	TMA Abutment Calcinabile (Vite RS3404 inclusa nella confezione)	12.0	4.9	3.3	10.5	RS5001





TMA Abutment Provvisorio		L	D1	D2	H	Codice Art.
	TMA Abutment Provvisorio in Titanio (Vite RS3404 inclusa nella confezione)	12.0	4.9	3.5	10.5	RS4900

TMA Viti		L	∅	Codice Art.
	TMA Vite per Transfer a Cucchiaino Aperto	14	2.1	RS5008
	TMA Vite per Transfer a Cucchiaino Chiuso	6.8	2.5	RS5009

Protesi Digitale per TMA™ - Touareg OS

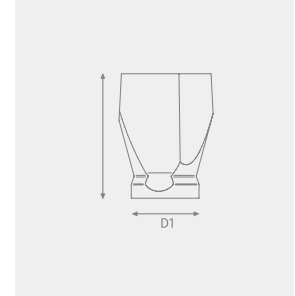
TMA Scan Body		L	D1	Codice Art.
	TMA Scan Body (Vite TM0001 inclusa nella confezione)	6.0	4.9	TM0006
		9.0	4.9	TM0009



TMA Analogo Modello Digitale		L	D1	D2	Codice Art.
	TMA Analogo Modello Digitale	12.0	4.9	3.35	RS1001

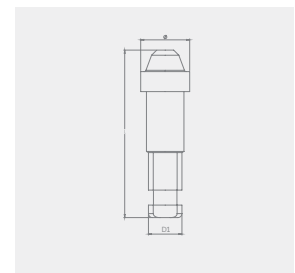

Utilizzare con driver protesico esagonale da 1.27.

TMA Abutment da incollaggio		L	D1	D2	H	W	Codice Art.
	TMA Abutment da incollaggio	4.9	4.9	3.9	3.4	0.5	TM0010
	TMA Abutment da incollaggio, low profile	4.9	5.5	4.5	4.4	0.5	TM0011

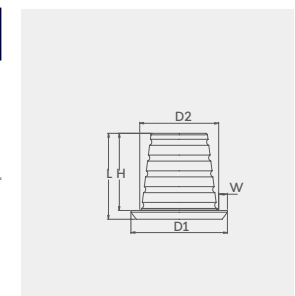

Vite TM0001 inclusa nella confezione

TMA Abutment Provvisorio		L	D1	D2	H	Codice Art.
	TMA Abutment Provvisorio in Titanio (Vite RS3404 inclusa nella confezione)	12.0	4.9	3.5	10.5	RS4900

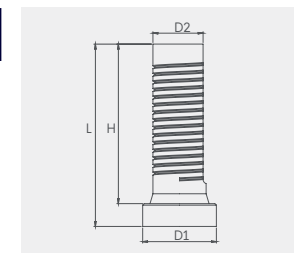

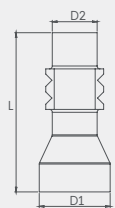

TMA Viti		Codice Art.
	TMA Vite Scan Body	TM0001

Protesi per TMA™ - WP

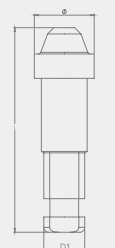

TMA Transfer		L	D1	D2	Codice Art.
	TMA Transfer per Impronta a Cucchiaino Aperto (Vite RS5008 inclusa nella confezione)	11.0	4.9	3.1	RS5006
	TMA Transfer per Impronta a Cucchiaino Chiuso (Vite RS5009 inclusa nella confezione)	8.0	4.9	4.1	RS5011



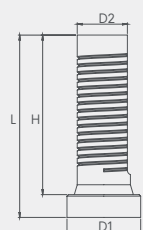

TMA Analogo		L	D1	Codice Art.
	TMA Analogo	16.8	4.9	RS5004



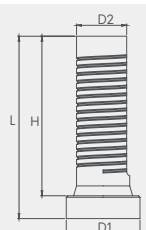

TMA Abutment Calcinabile		L	D1	D2	H	Codice Art.
	TMA Abutment Calcinabile (Vite RS3404 inclusa nella confezione)	12.0	4.9	3.3	10.5	RS5001





TMA Abutment Provvisorio		L	D1	D2	H	Codice Art.
	TMA Abutment Provvisorio in Titanio (Vite RS3404 inclusa nella confezione)	12.0	4.9	3.5	10.5	RS4900

TMA Viti		L	∅	Codice Art.
	TMA Vite per Transfer a Cucchiaino Aperto	14	2.1	RS5008
	TMA Vite per Transfer a Cucchiaino Chiuso	6.8	2.5	RS5009

Protesi Digitale per TMA™ - WP

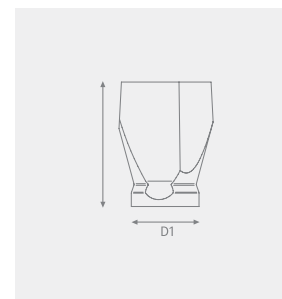
TMA Scan Body		L	D1	Codice Art.
	TMA Scan Body (Vite TM0001 inclusa nella confezione)	6.0	4.9	TM0006
		9.0	4.9	TM0009



TMA Analogo Modello Digitale		L	D1	D2	Codice Art.
	TMA Analogo Modello Digitale	12.0	4.9	3.35	RS1001

Utilizzare con driver protesico esagonale da 1.27.

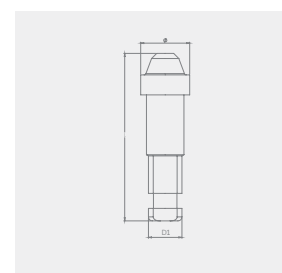

TMA Abutment da incollaggio		L	D1	D2	H	W	Codice Art.
	TMA Abutment da incollaggio	4.9	4.9	3.9	3.4	0.5	TM0010
	TMA Abutment da incollaggio, low profile	4.9	5.5	4.5	4.4	0.5	TM0011

Vite TM0001 inclusa nella confezione

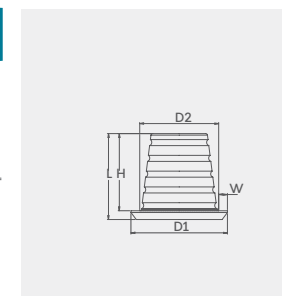

TMA Abutment Provvisorio		L	D1	D2	H	Codice Art.
	TMA Abutment Provvisorio in Titanio (Vite RS3404 inclusa nella confezione)	12.0	4.9	3.5	10.5	RS4900

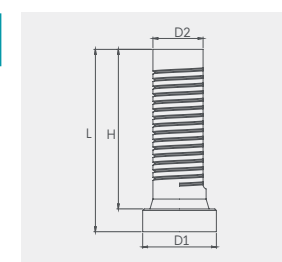

TMA Viti		Codice Art.
	TMA Vite Scan Body	TM0001

Zygomatic

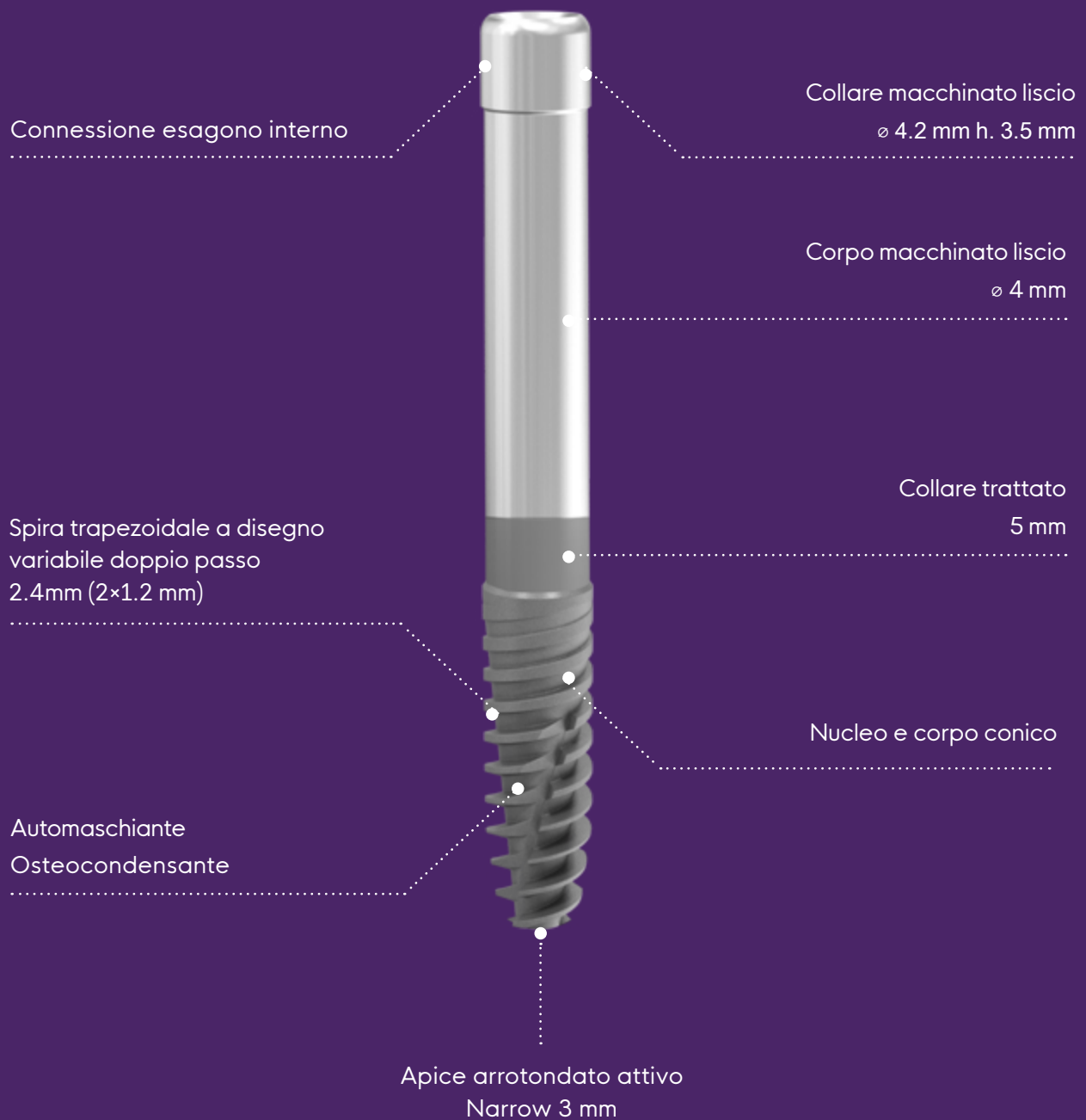

Zygomatic

Touareg™-OS Zygomatic è uno strumento raccomandato per la riabilitazione di gravi atrofie mascellari. E' utilizzabile nelle procedure intra o extra sinusali e per interventi a carico immediato ove siano soddisfatti i requisiti di stabilità. NON è indicato per le riabilitazioni di casi classificati ZAGA tipo IV.

Superficie OsseoFix™

Titanio grado 23 (Ti 6Al 4V ELI)

Lunghezza	Ø 4.2 mm
35 mm	ISZT3542
37.5 mm	ISZT3742
40 mm	ISZT4042
42.5 mm	ISZT4242
45 mm	ISZT4542
47.5 mm	ISZT4742
50 mm	ISZT5042
52.5 mm	ISZT5242
55 mm	ISZT5542

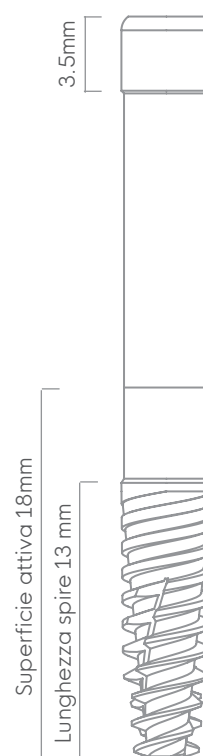

Zygomatic

Connessione esagono interno

Kit Chirurgico | ZGSK001





Frese Twist Step & Pilota	Codice Art.
Fresa di Marcatura 2.4mmD	DL5524
Fresa Pilota 1.8/2.5mmD x 35-55mmL	DL5525
Fresa Twist Step 2.5/3.2mmD x 35-55mmL	DL5532
Fresa Twist Step 3.2/3.6mmD x 35-55mmL	DL5536



Sonda di profondità	Codice Art.
Sonda di profondità 35-55mm	ZGDP01
Cacciavite chirurgico	RS7001



Frese diamantate	Codice Art.
Fresa diamantata 4.2mmDx35mmL, Medium	ZGDB3542M
Fresa diamantata 4.2mmDx35mmL, Coarse	ZGDB3542C



Strumentario	Codice Art.
Driver per Cricchetto Star - Long	RP0005
RS 2.4 Driver Esagonale per Cricchetto-Short	RS6011
RS 2.4 Driver Esagonale per Cricchetto-Long	RS6012
RS Adattatore Esagonale per Contrangolo Medium/Long	RS9029
1.27 Driver Esagonale per Cricchetto-Short	RS6080
Cricchetto	RS6100
Adattatore Driver per Cricchetto	RA0050

Frese Zygomatic Twist Step

Descrizione e caratteristiche

Le frese Adin per impianto Touareg™-OS Zygomatic sono strumenti dedicati all'esecuzione dell'osteotomia in osso zigomatico. La particolare forma denominata Twist Step, consente di realizzare una preparazione graduale, assicurando la massima precisione e stabilità.

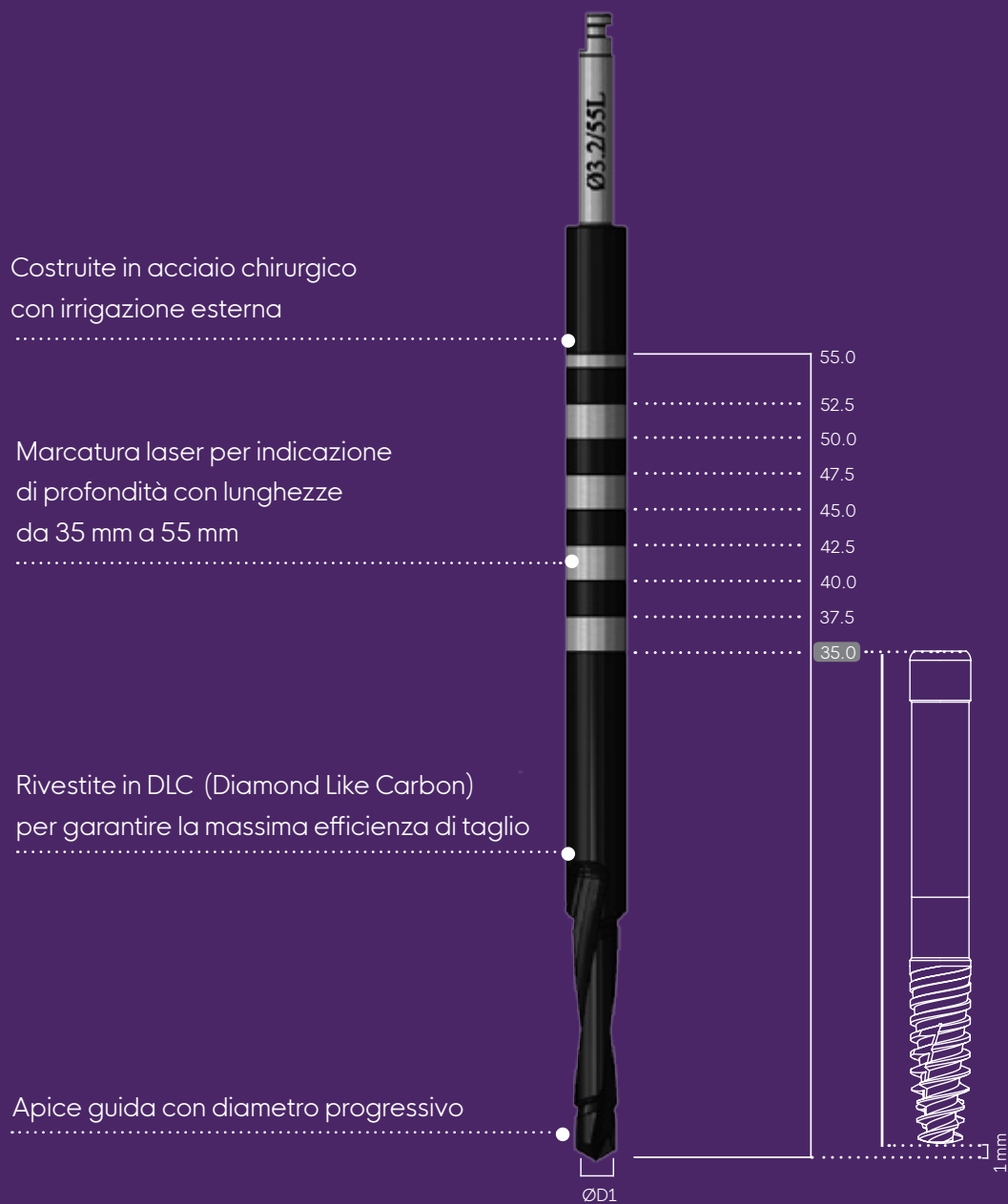

Frese



DL5524 Fresa di Marcatura 2.4mmD



DL5525 Fresa Pilota 1.8/2.5mmD x 35-55mmL







DL5532 Fresa Twist Step 2.8/3.2mmD x 35-55mmL

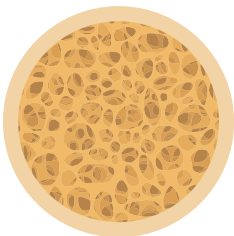

DL5536 Fresa Twist Step 3.2/3.6mmD x 35-55mmL

Protocollo di foratura

Max velocità di foratura	800-1200	600	600	600
				
	Fresa di Marcatura Ø2.4mm	Fresa Pilota Ø2.5mm	Fresa Twist Ø3.2mm	Fresa Twist Ø3.6mm

ATTENZIONE: la fresa effettua una preparazione di 1 mm più profonda rispetto alla lunghezza dell'impianto

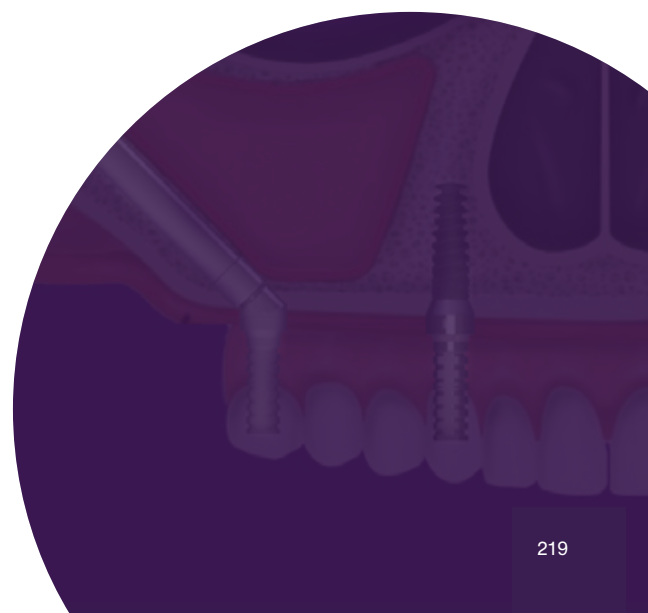

Strumentario



RS 2.4mm Driver Esagonale per Cricchetto
- Long RS6012



RS 2.4mm Driver Esagonale per Cricchetto - Short RS6011



1.27mm Driver Esagonale per Cricchetto
- Short RS6080



RS Adattatore Esagonale per Contrangolo - Long RS9029



Adattatore Driver per Cricchetto RA0050



Cricchetto RS6100

Star



Driver per Cricchetto Star - Long RP0005



Driver per Cricchetto Star - Short RP0065



Driver Manuale Star - Long RP0004



Driver Manuale Star - Short RP0064

Driver TMA dritti



TMA Driver Esagonale per Cricchetto - Long RS6196



TMA Adattatore Esagonale per Contrangolo - Long RS6195A



TMA Driver Esagonale per Cricchetto - Short RS6197





TMA Adattatore Esagonale per Contrangolo - Short RS6194

TMA™ - Multi Unit

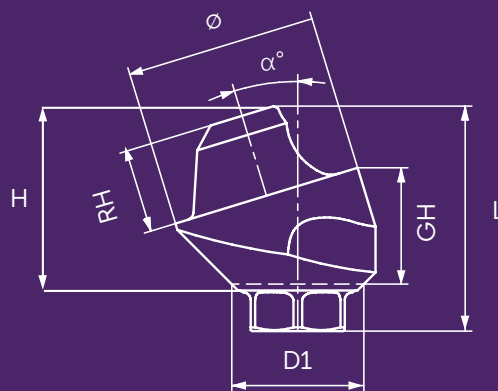
Torque raccomandato 35(Ncm)



TMA dritti		L	Ø	D1	H	GH	RH	Codice Art.
	RS Abutment Transmucoso Dritto 1mm	3.7	4.9	3.4	3.1	1	2.1	RS3731
	RS Abutment Transmucoso Dritto 2mm	4.7	4.9	3.4	4.1	2	2.1	RS3732
	RS Abutment Transmucoso Dritto 3mm	5.7	4.9	3.4	5.1	3	2.1	RS3733
	RS Abutment Transmucoso Dritto 4mm	6.7	4.9	3.4	6.1	4	2.1	RS3729
	RS Abutment Transmucoso Dritto 5mm	7.7	4.9	3.4	7.1	5	2.1	RS3730

Viti incluse nella confezione		L	Ø	Codice Art.
	RS Vite di Ritenzione per TMA 1mm	7.8	3.1	RS3406
	RS Vite di Ritenzione per TMA 2mm	8.8	3.1	RS3407
	RS Vite di Ritenzione per TMA 3mm	9.8	3.1	RS3408
	RS Vite di Ritenzione per TMA 4mm	10.8	3.1	RS3409
	RS Vite di Ritenzione per TMA 5mm	11.8	3.1	RS3412



TMA angolati		L	Ø	D1	H	GH	RH	Codice Art.
	RS Abutment Transmucoso Angolato 17° 2mm	5.17	4.9	3.4	-	2	2.1	RS3734
	RS Abutment Transmucoso Angolato 17° 3mm	6.05	4.9	3.4	-	3	2.1	RS3737
	RS Abutment Transmucoso Angolato 30° 3mm	5.7	4.9	3.4	-	3	2.1	RS3735
	RS Abutment Transmucoso Angolato 30° 4mm	6.5	4.9	3.4	-	4	2.1	RS3738
	RS Abutment Transmucoso Angolato 45° 4mm	5.94	4.9	3.4	-	4	2.1	RS3736
	RS Abutment Transmucoso Angolato 52° 5mm	5.0	4.9	3.4	-	5	2.1	RS3739
	RS Abutment Transmucoso Angolato 60° 5mm	7.5	4.9	3.4	-	5	2.1	RS3740

Vite RS3403 inclusa nella confezione

TMA Cappetta di Guarigione		L	Ø	D1	D2	H	GH	RH	Codice Art.
	TMA Cappetta di Guarigione (Vite RS 3404 inclusa)	5.5	4.9	-	3.5	-	-	-	RS5005
		7.0	4.9	-	3.5	-	-	-	RS5003

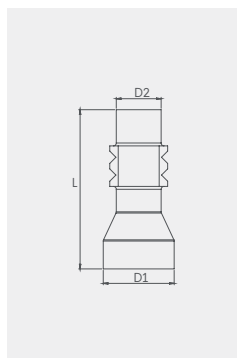
Protesi per TMA™ - Zygomatic



TMA Transfer		L	D1	D2	Codice Art.
	TMA Transfer per Impronta a Cucchiaino Aperto (Vite RS5008 inclusa nella confezione)	11.0	4.9	3.1	RS5006
	TMA Transfer per Impronta a Cucchiaino Chiuso (Vite RS5009 inclusa nella confezione)	8.0	4.9	4.1	RS5011

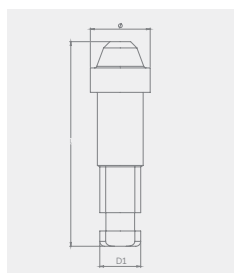

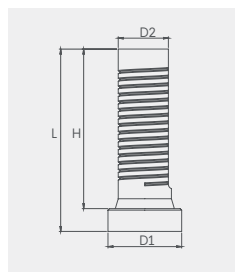

TMA Anologo		L	D1	Codice Art.
	TMA Anologo	16.8	4.9	RS5004



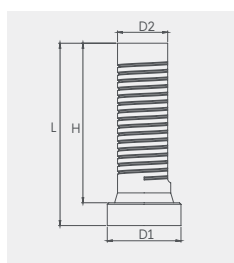

TMA Abutment Calcinabile		L	D1	D2	H	Codice Art.
	TMA Abutment Calcinabile (Vite RS3404 inclusa nella confezione)	12.0	4.9	3.3	10.5	RS5001





TMA Abutment Provvisorio		L	D1	D2	H	Codice Art.
	TMA Abutment Provvisorio in Titanio (Vite RS3404 inclusa nella confezione)	12.0	4.9	3.5	10.5	RS4900

TMA Viti		L	∅	Codice Art.
	TMA Vite per Transfer a Cucchiaino Aperto	14	2.1	RS5008
	TMA Vite per Transfer a Cucchiaino Chiuso	6.8	2.5	RS5009

Protesi Digitale per TMA™ - Zygomatic

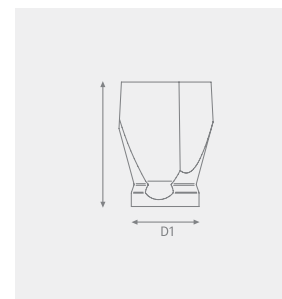

TMA Scan Body		L	D1	Codice Art.
	TMA Scan Body (Vite TM0001 inclusa nella confezione)	6.0	4.9	TM0006
		9.0	4.9	TM0009

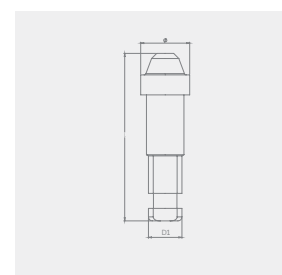

TMA Analogo Modello Digitale		L	D1	D2	Codice Art.
	TMA Analogo Modello Digitale	12.0	4.9	3.35	RS1001



Utilizzare con driver protesico esagonale da 1.27.

TMA Abutment da incollaggio		L	D1	D2	H	W	Codice Art.
	TMA Abutment da incollaggio	4.9	4.9	3.9	3.4	0.5	TM0010
	TMA Abutment da incollaggio, low profile	4.9	5.5	4.5	4.4	0.5	TM0011

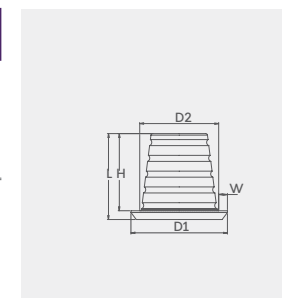

Vite TM0001 inclusa nella confezione

TMA Abutment Provvisorio		L	D1	D2	H	Codice Art.
	TMA Abutment Provvisorio in Titanio (Vite RS3404 inclusa nella confezione)	12.0	4.9	3.5	10.5	RS4900

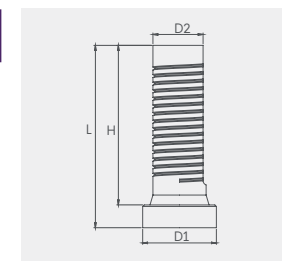

TMA Viti		Codice Art.
	TMA Vite Scan Body	TM0001



Kit Stop





Ogni Stop è marcato con il diametro e la lunghezza.

Si prega di notare che alcuni sono idonei per frese lunghe e corte secondo quanto segue:

L: Lunghezza di foratura per frese lunghe - Long (18 mm)

S: : Lunghezza di foratura per frese corte - Short (13 mm)



Kit Stop per Frese S1001 | Regular Long



Frese



Codice Art. DL1820

L

Fresa Pilota 2mmD x 8-18mmL

35.5



Codice Art. DL1828

L

Fresa Twist Step 2.3/2.8mmD x 8-18mmL

35.5



Codice Art. DL1832

L

Fresa Twist Step 2.8/3.2mmD x 8-18mmL

35.5



Codice Art. DL1836

L

Fresa Twist Step 3.2/3.6mmD x 8-18mmL

35.5

Stop	L	Codice Art.
Stop per Fresa Lunga L6 1820	6.0	S1820L6
Stop per Fresa Lunga L8 1820	8.0	S1820L8
Stop per Fresa Lunga L10 1820	10.0	S1820L10
Stop per Fresa Lunga L11.5 1820	11.5	S1820L11.5
Stop per Fresa Lunga L13/Short L8 1820	13.0	S1820L13
Stop per Fresa Lunga L15/Short L10 1820	15.0	S1820L15
Stop per Fresa Lunga L16 1820	16.0	S1820L16
Stop per Fresa Lunga L6 1828	6.0	S1828L6
Stop per Fresa Lunga L8 1828	8.0	S1828L8
Stop per Fresa Lunga L10 1828	10.0	S1828L10
Stop per Fresa Lunga L11.5 1828	11.5	S1828L11.5
Stop per Fresa Lunga L13/Short L8 1828	13.0	S1828L13
Stop per Fresa Lunga L15/Short L10 1828	15.0	S1828L15
Stop per Fresa Lunga L16 1828	16.0	S1828L16
Stop per Fresa Lunga L6 1832	6.0	S1832L6
Stop per Fresa Lunga L8 1832	8.0	S1832L8
Stop per Fresa Lunga L10 1832	10.0	S1832L10
Stop per Fresa Lunga L11.5 1832	11.5	S1832L11.5
Stop per Fresa Lunga L13/Short L8 1832	13.0	S1832L13
Stop per Fresa Lunga L15/Short L10 1832	15.0	S1832L15
Stop per Fresa Lunga L16 1832	16.0	S1832L16
Stop per Fresa Lunga L6 1836	6.0	S1836L6
Stop per Fresa Lunga L8 1836	8.0	S1836L8
Stop per Fresa Lunga L10 1836	10.0	S1836L10
Stop per Fresa Lunga L11.5 1836	11.5	S1836L11.5
Stop per Fresa Lunga L13/Short L8 1836	13.0	S1836L13
Stop per Fresa Lunga L15/Short L10 1836	15.0	S1836L15
Stop per Fresa Lunga L16 1836	16.0	S1836L16

Kit Stop per Frese S1002 | Wide Long



Frese



Codice Art. DL1842

L

Fresa Twist Step 3.8/4.2mmD x 8-18mmL

35.5



Codice Art. DL1846

L

Fresa Twist Step 4.2/4.6mmD x 8-18mmL

35.5



Codice Art. DL1852

L

Fresa Twist Step 4.8/5.2mmD x 8-18mmL

35.5



Codice Art. DL1856

L

Fresa Twist Step 5.2/5.6mmD x 8-18mmL

35.5

Stop	L	Codice Art.
Stop per Fresa Lunga L6 1842	6.0	S1842L6
Stop per Fresa Lunga L8 1842	8.0	S1842L8
Stop per Fresa Lunga L10 1842	10.0	S1842L10
Stop per Fresa Lunga L11.5 1842	11.5	S1842L11.5
Stop per Fresa Lunga L13/Short L8 1842	13.0	S1842L13
Stop per Fresa Lunga L15/Short L10 1842	15.0	S1842L15
Stop per Fresa Lunga L16 1842	16.0	S1842L16
Stop per Fresa Lunga L6 1846	6.0	S1846L6
Stop per Fresa Lunga L8 1846	8.0	S1846L8
Stop per Fresa Lunga L10 1846	10.0	S1846L10
Stop per Fresa Lunga L11.5 1846	11.5	S1846L11.5
Stop per Fresa Lunga L13/Short L8 1846	13.0	S1846L13
Stop per Fresa Lunga L15/Short L10 1846	15.0	S1846L15
Stop per Fresa Lunga L16 1846	16.0	S1846L16
Stop per Fresa Lunga L6 1852	6.0	S1852L6
Stop per Fresa Lunga L8 1852	8.0	S1852L8
Stop per Fresa Lunga L10 1852	10.0	S1852L10
Stop per Fresa Lunga L11.5 1852	11.5	S1852L11.5
Stop per Fresa Lunga L13/Short L8 1852	13.0	S1852L13
Stop per Fresa Lunga L15/Short L10 1852	15.0	S1852L15
Stop per Fresa Lunga L16 1852	16.0	S1852L16
Stop per Fresa Lunga L6 1856	6.0	S1856L6
Stop per Fresa Lunga L8 1856	8.0	S1856L8
Stop per Fresa Lunga L10 1856	10.0	S1856L10
Stop per Fresa Lunga L11.5 1856	11.5	S1856L11.5
Stop per Fresa Lunga L13/Short L8 1856	13.0	S1856L13
Stop per Fresa Lunga L15/Short L10 1856	15.0	S1856L15
Stop per Fresa Lunga L16 1856	16.0	S1856L16

Kit Stop per Frese S1003 | Regular Short



Frese



Codice Art. DL1320

L

Fresa Pilota 2mmD x 6-13mmL

30.5



Codice Art. DL1328

L

Fresa Twist Step 2.3/2.8mmD x 6-13mmL

30.5



Codice Art. DL1332

L

Fresa Twist Step 2.8/3.2mmD x 6-13mmL

30.5



Codice Art. DL1336

L

Fresa Twist Step 3.2/3.6mmD x 6-13mmL

30.5

Stop	L	Codice Art.
Stop per Fresa Corta L6 1320	6.0	S1320L6
Stop per Fresa Corta L11.5 1320	11.5	S1320L11.5
Stop per Fresa Corta L6 1328	6.0	S1328L6
Stop per Fresa Corta L11.5 1328	11.5	S1328L11.5
Stop per Fresa Corta L6 1332	6.0	S1332L6
Stop per Fresa Corta L11.5 1332	11.5	S1332L11.5
Stop per Fresa Corta L6 1336	6.0	S1336L6
Stop per Fresa Corta L11.5 1336	11.5	S1336L11.5
Stop per Fresa Lunga L13/Short L8 1820	13.0	S1820L13
Stop per Fresa Lunga L15/Short L10 1820	15.0	S1820L15
Stop per Fresa Lunga L13/Short L8 1828	13.0	S1828L13
Stop per Fresa Lunga L15/Short L10 1828	15.0	S1828L15
Stop per Fresa Lunga L13/Short L8 1832	13.0	S1832L13
Stop per Fresa Lunga L15/Short L10 1832	15.0	S1832L15
Stop per Fresa Lunga L13/Short L8 1836	13.0	S1836L13
Stop per Fresa Lunga L15/Short L10 1836	15.0	S1836L15

Kit Stop per Frese S1004 | Wide Short



Frese



Codice Art. DL1342

L

Fresa Twist Step 3.8/4.2mmD x 6-13mmL

30.5



Codice Art. DL1346

L

Fresa Twist Step 4.2/4.6mmD x 6-13mmL

30.5



Codice Art. DL1352

L

Fresa Twist Step 4.8/5.2mmD x 6-13mmL

30.5



Codice Art. DL1356

L

Fresa Twist Step 5.2/5.6mmD x 6-13mmL

30.5

Stop

L

Codice Art.

Stop per Fresa Corta L6 1342	6.0	S1320L6
Stop per Fresa Corta L11.5 1342	11.5	S1320L11.5
Stop per Fresa Corta L6 1346	6.0	S1328L6
Stop per Fresa Corta L11.5 1346	11.5	S1328L11.5
Stop per Fresa Corta L6 1352	6.0	S1332L6
Stop per Fresa Corta L11.5 1352	11.5	S1332L11.5
Stop per Fresa Corta L6 1356	6.0	S1336L6
Stop per Fresa Corta L11.5 1356	11.5	S1336L11.5
Stop per Fresa Lunga L13/Short L8 1842	13.0	S1820L13
Stop per Fresa Lunga L15/Short L10 1842	15.0	S1820L15
Stop per Fresa Lunga L13/Short L8 1846	13.0	S1828L13
Stop per Fresa Lunga L15/Short L10 1846	15.0	S1828L15
Stop per Fresa Lunga L13/Short L8 1852	13.0	S1832L13
Stop per Fresa Lunga L15/Short L10 1852	15.0	S1832L15
Stop per Fresa Lunga L13/Short L8 1856	13.0	S1836L13
Stop per Fresa Lunga L15/Short L10 1856	15.0	S1836L15

Lifetime Warranty

A Sense of Security for You & Your Patients



ADIN Dental Implant Systems Ltd fornisce una garanzia a vita che prevede la sostituzione di impianti e/o parti protesiche prodotte da ADIN.

Per maggiori informazioni, termini e modalità consultare il sito Adin al link:

www.adin-implants.com/lifetime-warranty



Personal touch
Professional approach

Industrial Park Allon Tavor
POB 1128, Afula 1811101, Israel
T. +972-4-6426732
info@adin-implants.com
www.adin-implants.com

Servizio Clienti Italia

HTD Medical s.r.l.
Via M. Buonarroti 2B, 53013 Gaiole in Chianti (SI)
Tel: +39 0577 1910565
info@htd-medical.it • www.htd-medical.it